

STUDIO TAFELS

Versie 1 januari 2021

TE LEUK EVENTDESIGN

— concept en creatie —

STUDIO TAFEL (3 meter)

Optie 1



De studiotafel van 3,00 meter lang is geschikt voor tafelgesprekken met max. 3 personen (in Corona-tijden).

STUDIO TAFEL

Optie 1

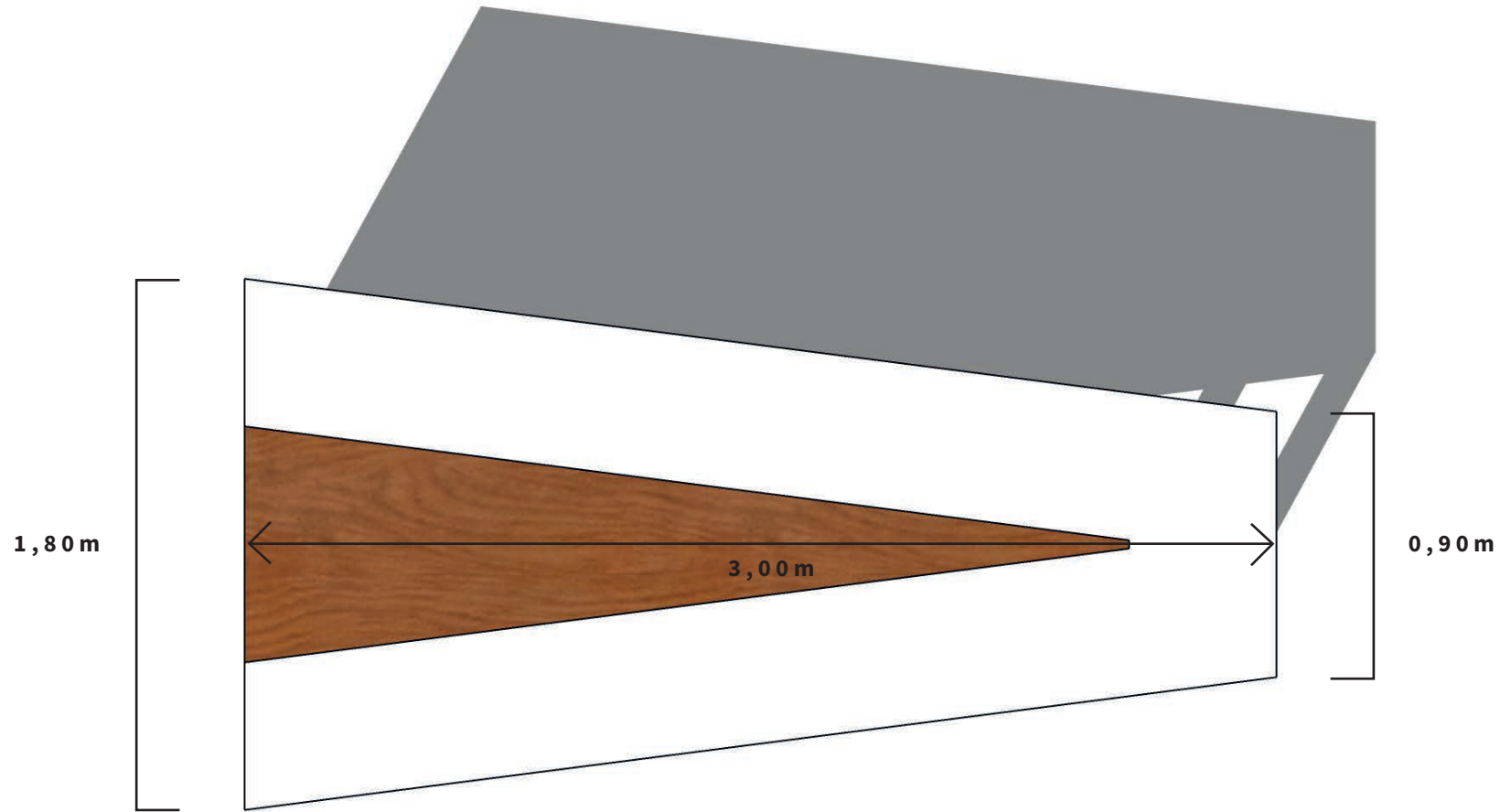

STUDIO TAFEL

Optie 1

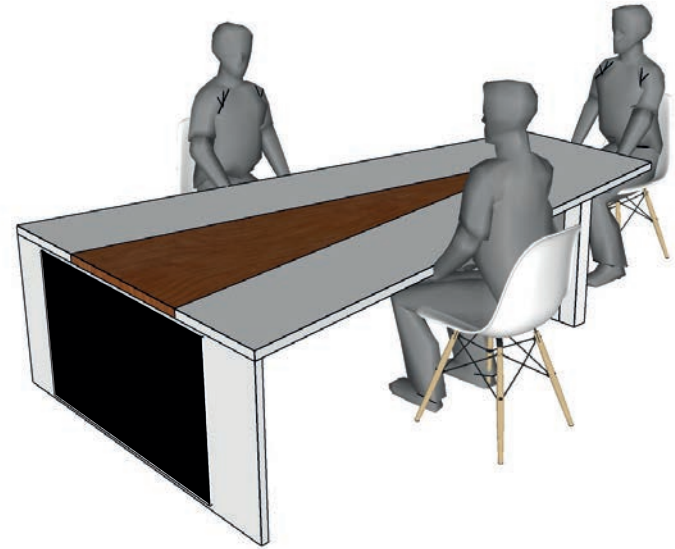
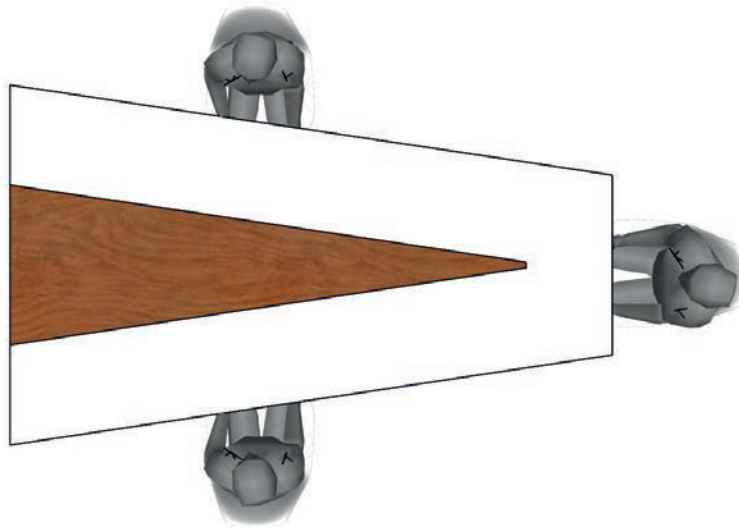

STUDIO TAFEL (afstand)

Optie 1

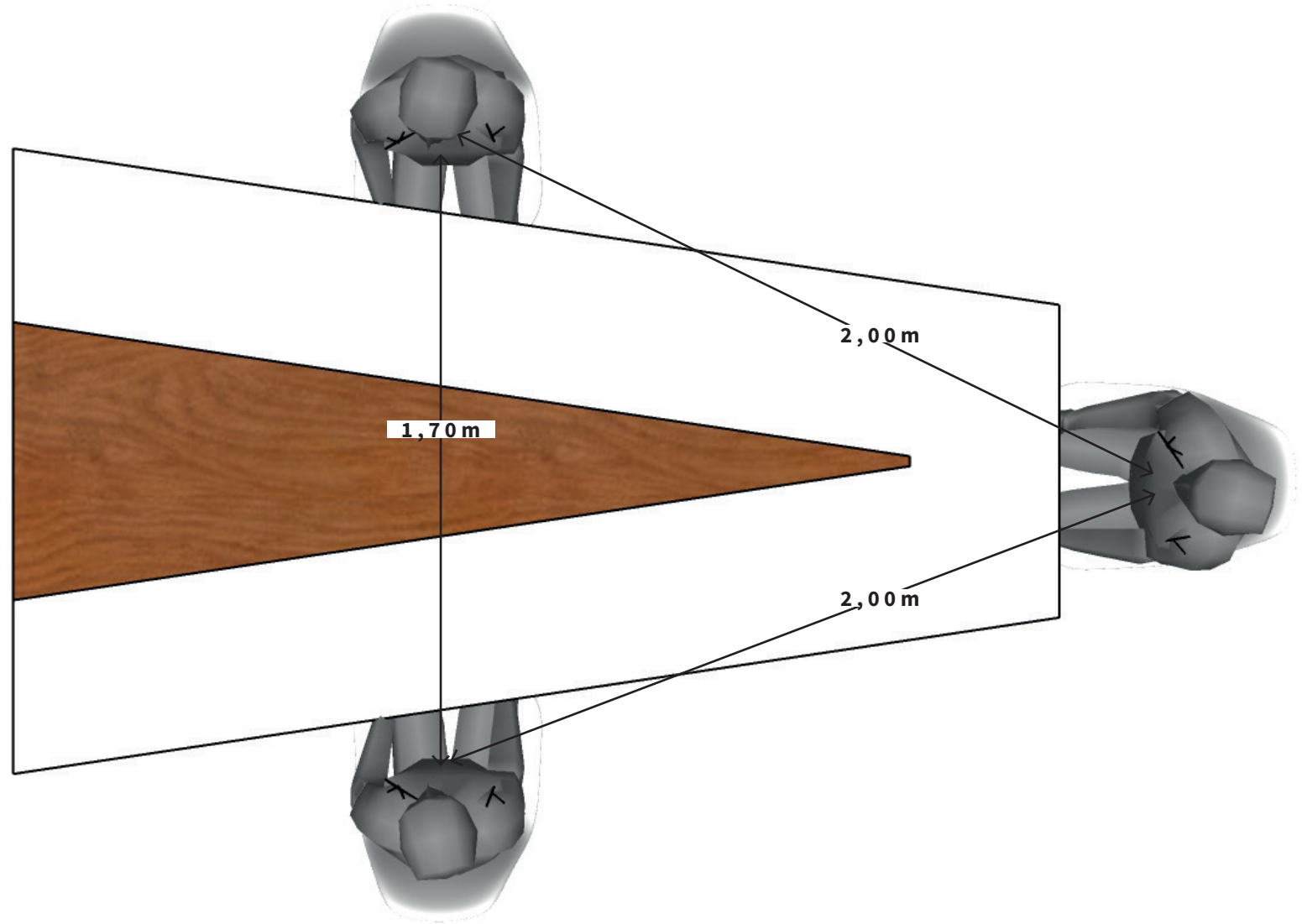

STUDIO TAFEL (3,5 meter)

Optie 2



*De studiotafel van **3,50 meter lang** is geschikt voor tafelgesprekken met **max. 5 personen** (in Corona-tijden)*

STUDIO TAFEL

Optie 2

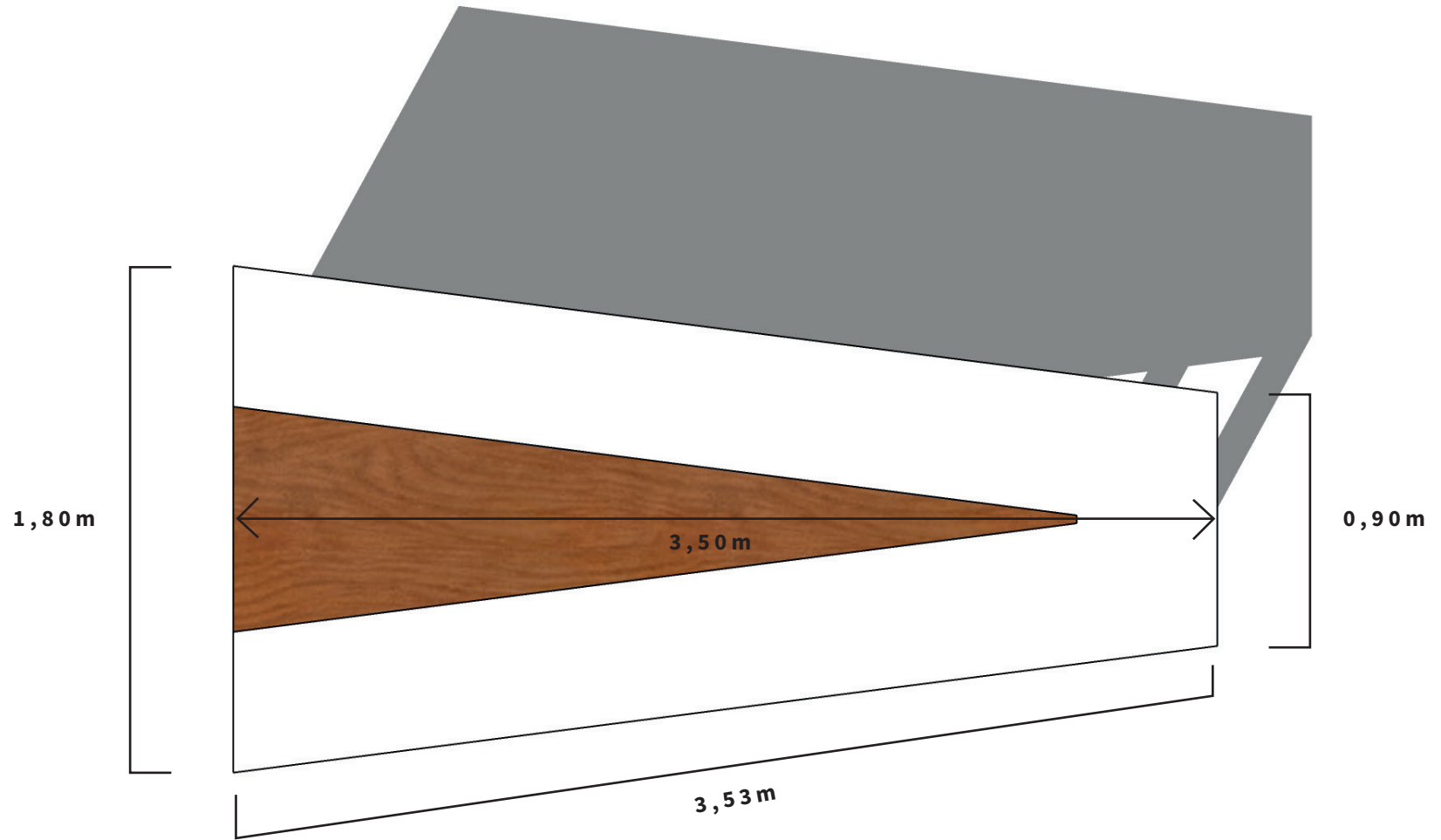

STUDIO TAFEL
Optie 2

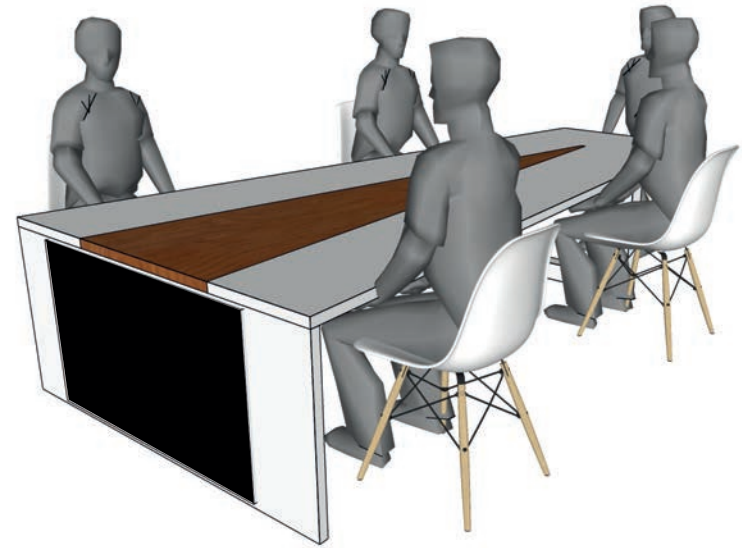
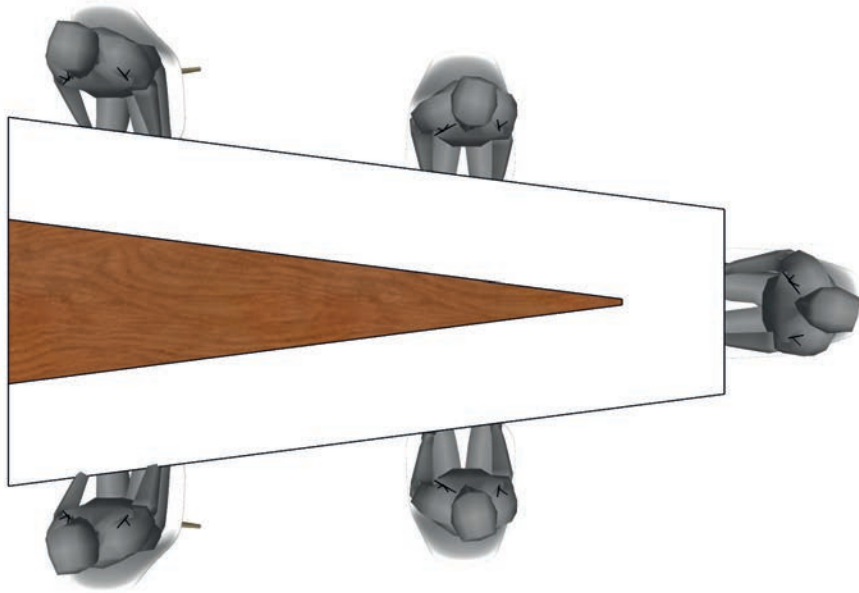

STUDIO TAFEL (afstand)

Optie 2

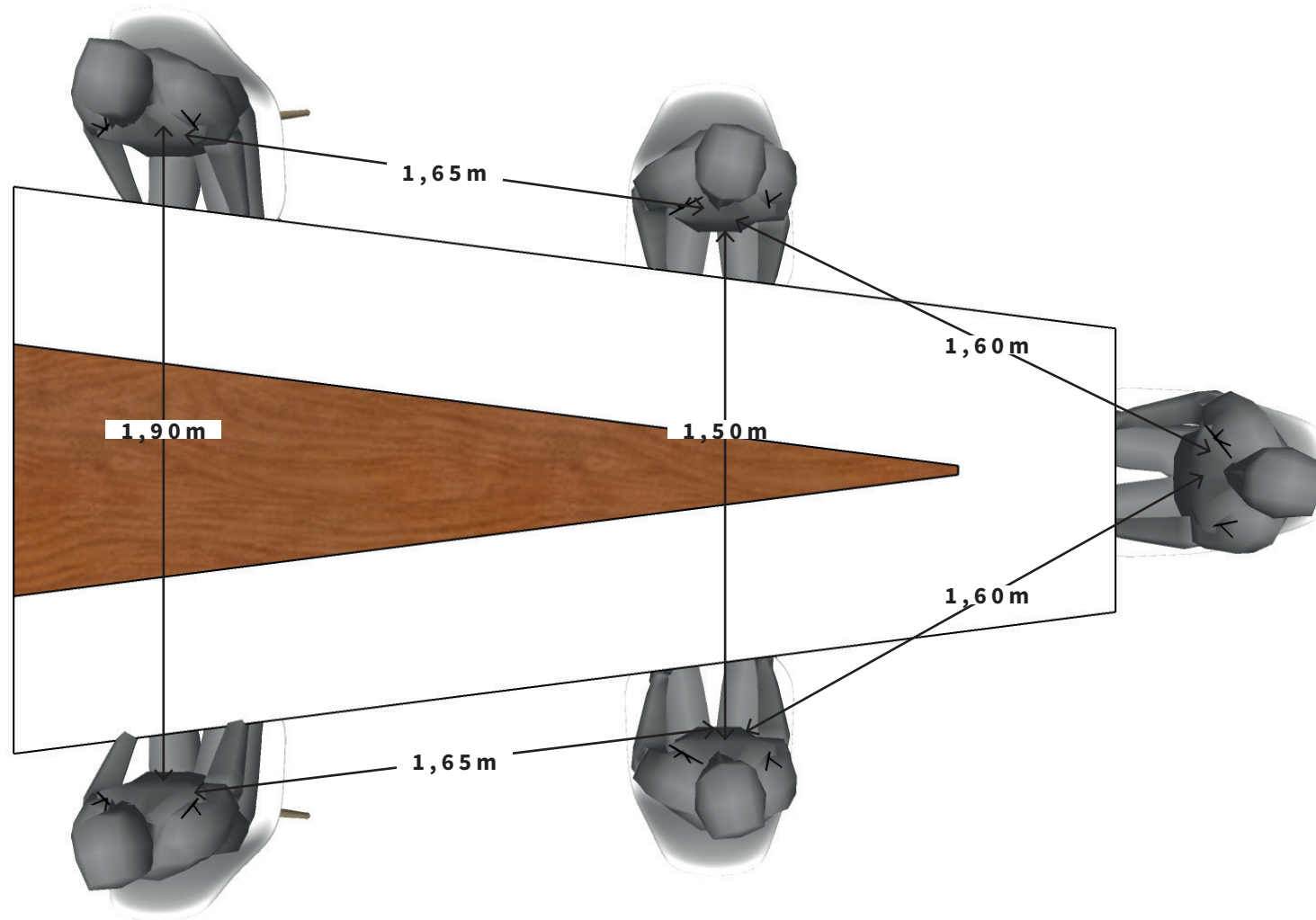

STUDIO TAFEL

Optie 3



CUSTOM MADE LOGO

Er zijn meerdere manieren om de studiotafels te personaliseren. Bijvoorbeeld jullie bedrijfslogo gebrand in het hout om de tafel nog persoonlijker te maken. Wij kunnen ook de houten punt in een kleur maken die past bij de huisstijl.

STUDIO TAFEL (3,60 meter), lift proof

Optie 4



*De studiotafel van **3,60 meter lang** is geschikt voor tafelgesprekken met **max. 5 personen** (in Corona-tijden)*

STUDIO TAFEL, lift proof

Optie 4



STUDIO TAFEL, lift proof
Optie 4

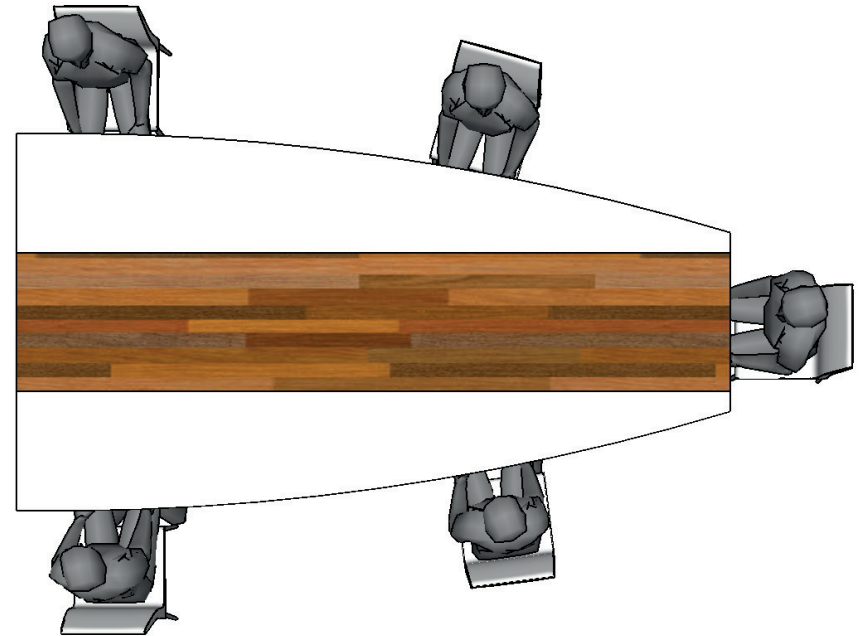
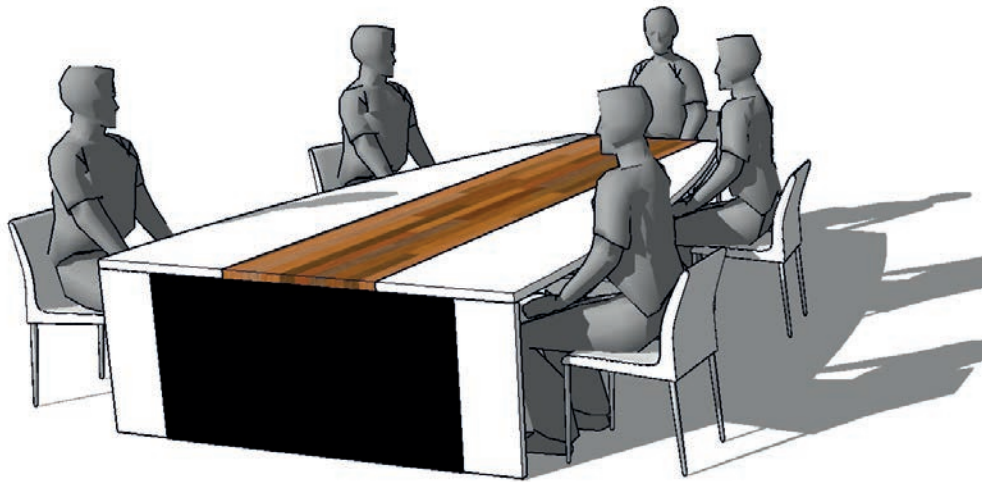

STUDIO TAFEL (afstand), lift proof

Optie 4

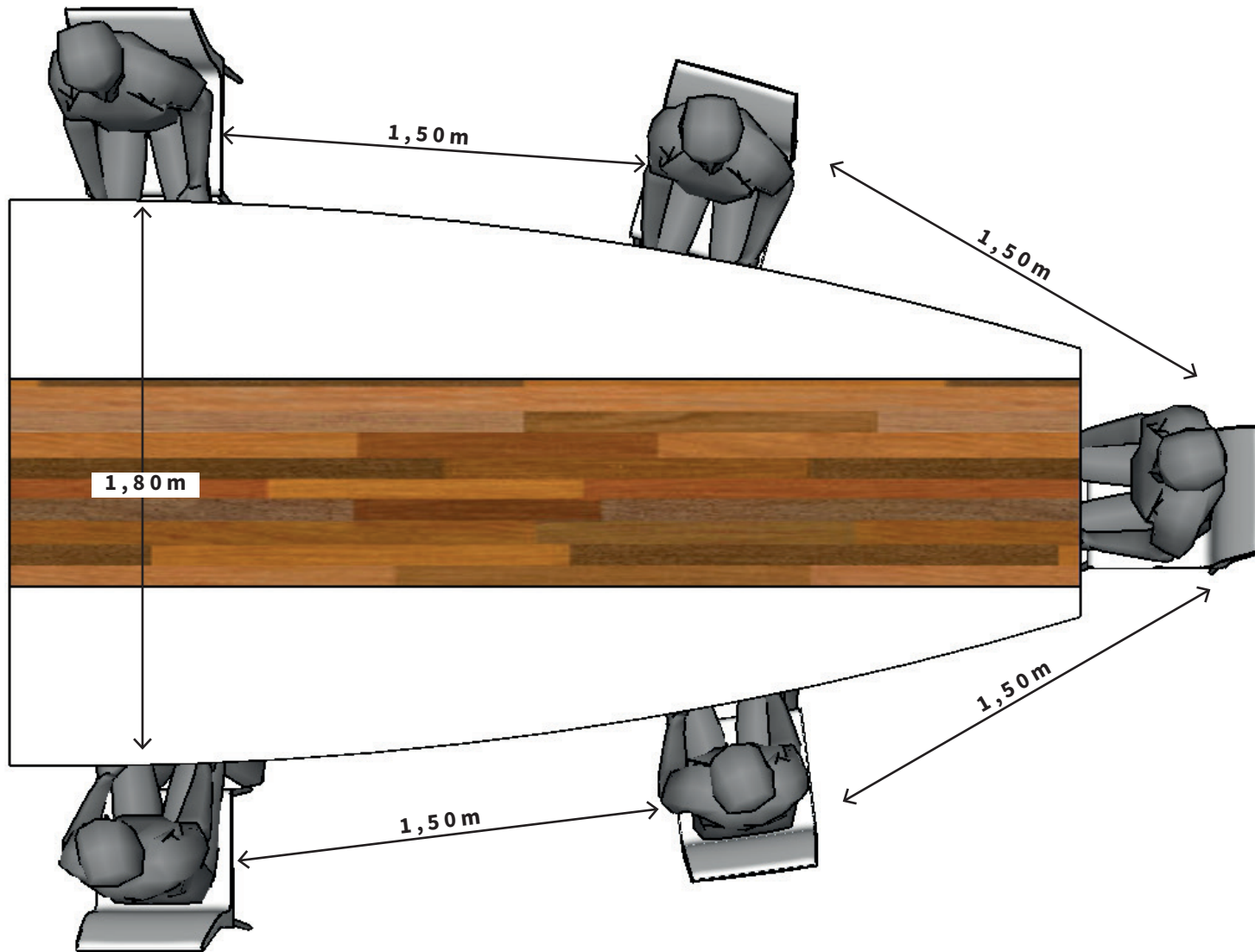

STUDIO TAFEL (3,60 meter), duo presentatie en lift proof

Optie 5

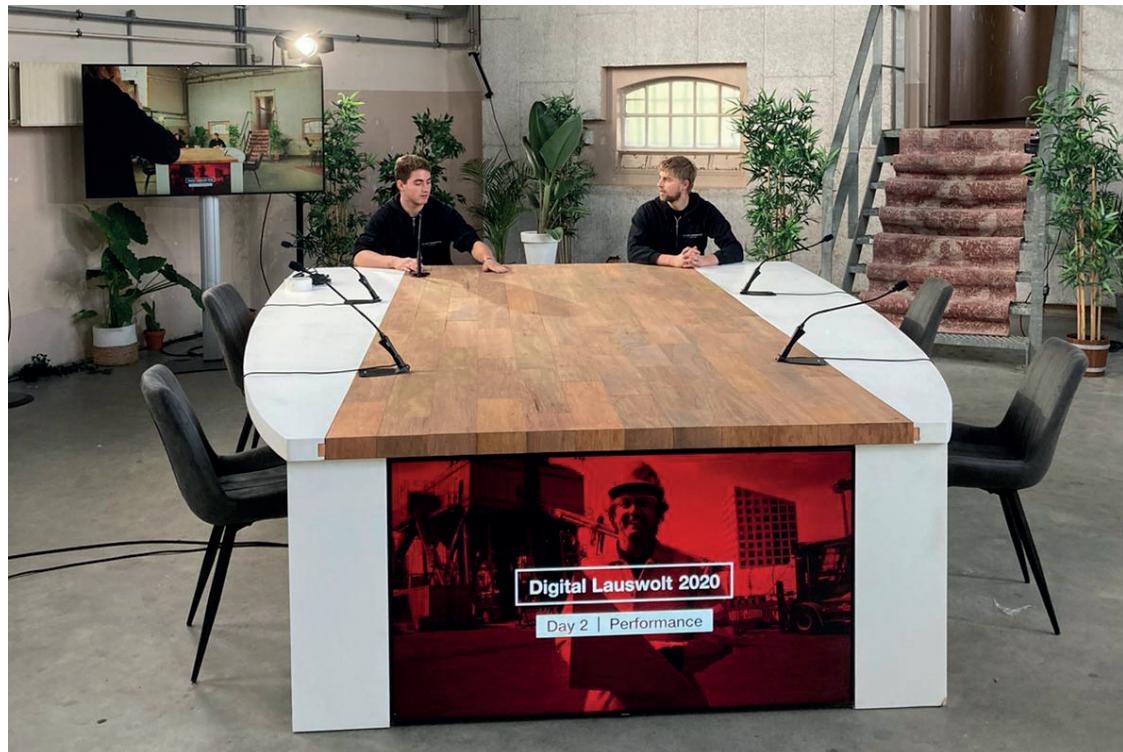

*De studiotafel van **3,60 meter lang** is geschikt voor tafelgesprekken met **max. 6 personen** (in Corona-tijden)*

STUDIO TAFEL, duo presentatie en lift proof

Optie 5

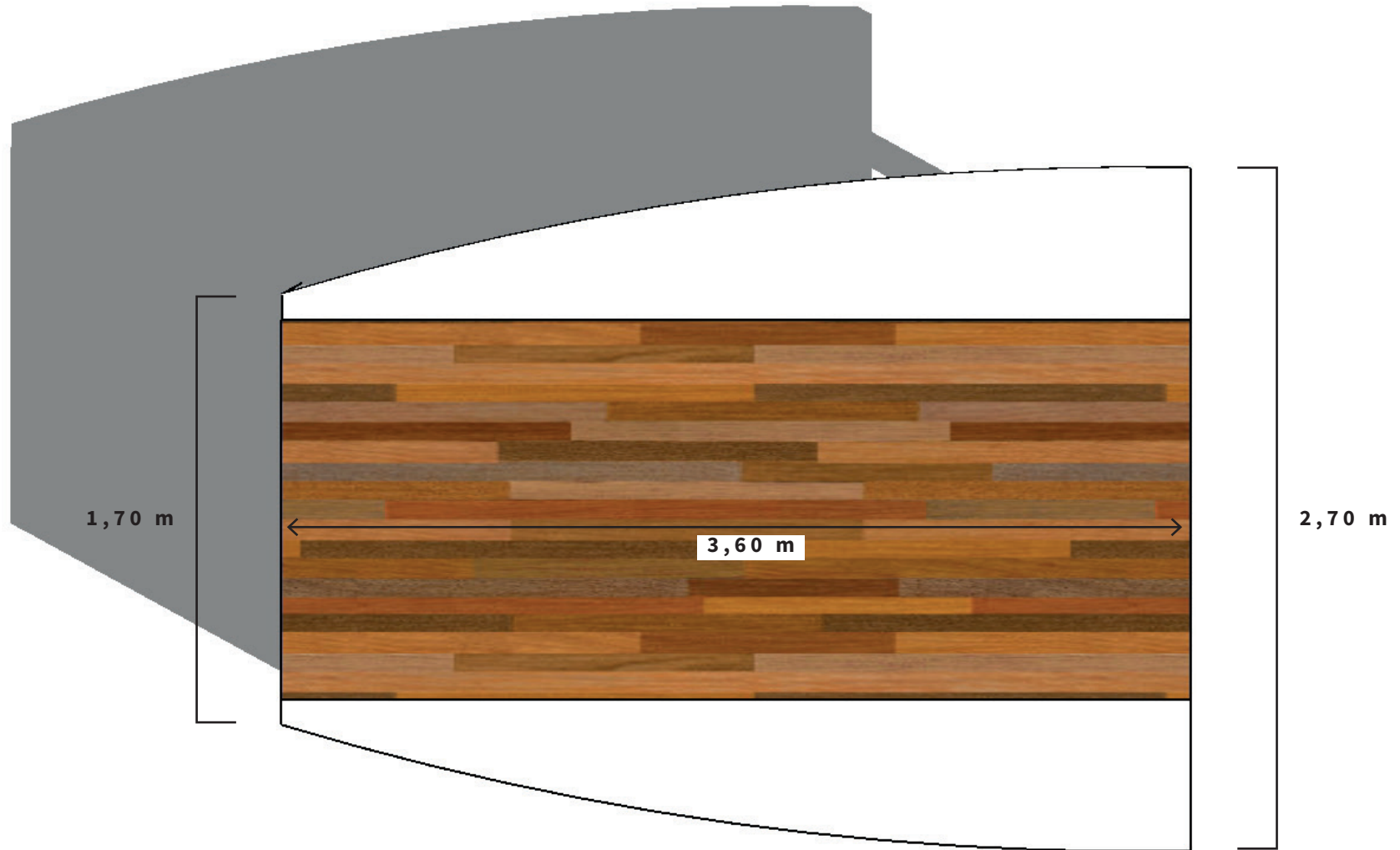

STUDIO TAFEL, duo presentatie en lift proof

Optie 5

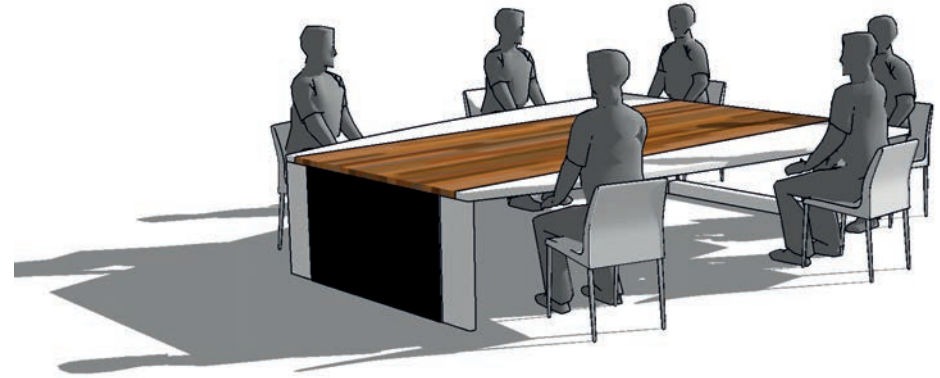
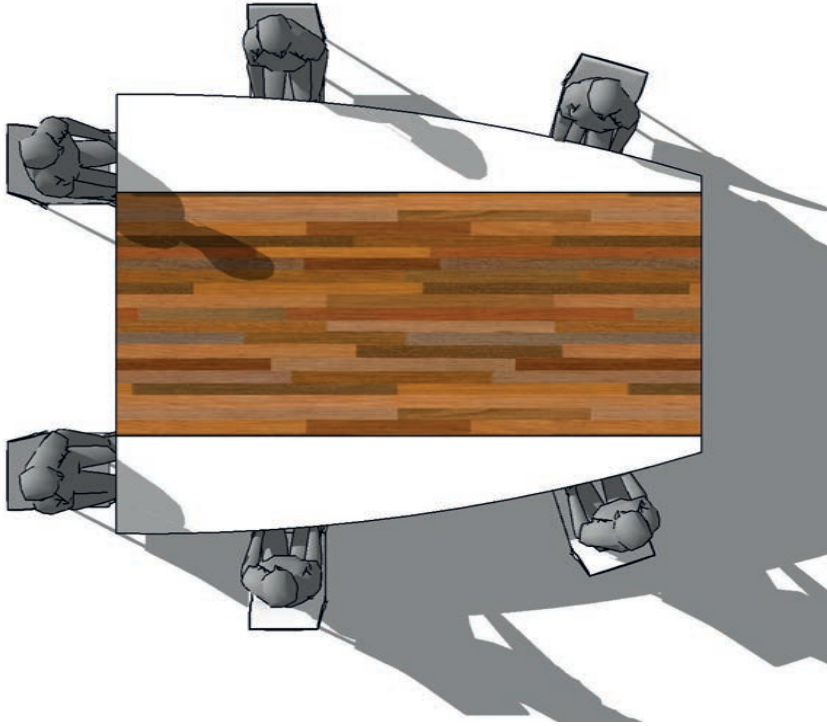

STUDIO TAFEL (afstand), duo presentatie en lift proof

Optie 5

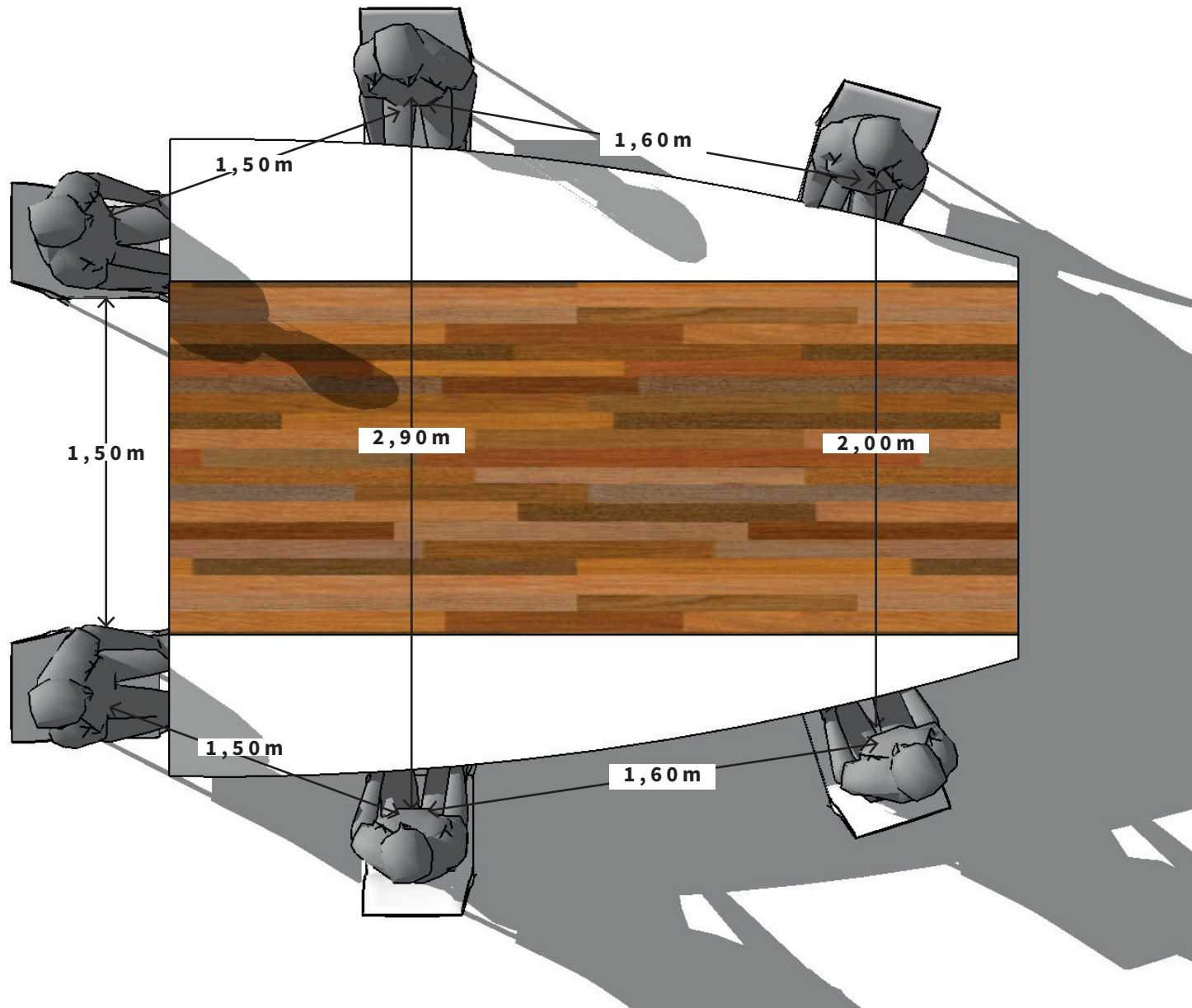

Studio balie

Optie 1



*De studiobalie van **4,50 meter lang** is geschikt voor een gesprek met **max. 3 personen** (in Corona-tijden)*

Studio balie

Optie 1



Studio balie

Optie 1



*Maten van de Balie **4,50 meter** breed x **1,10 meter** hoog*

Studio balie

Optie 1

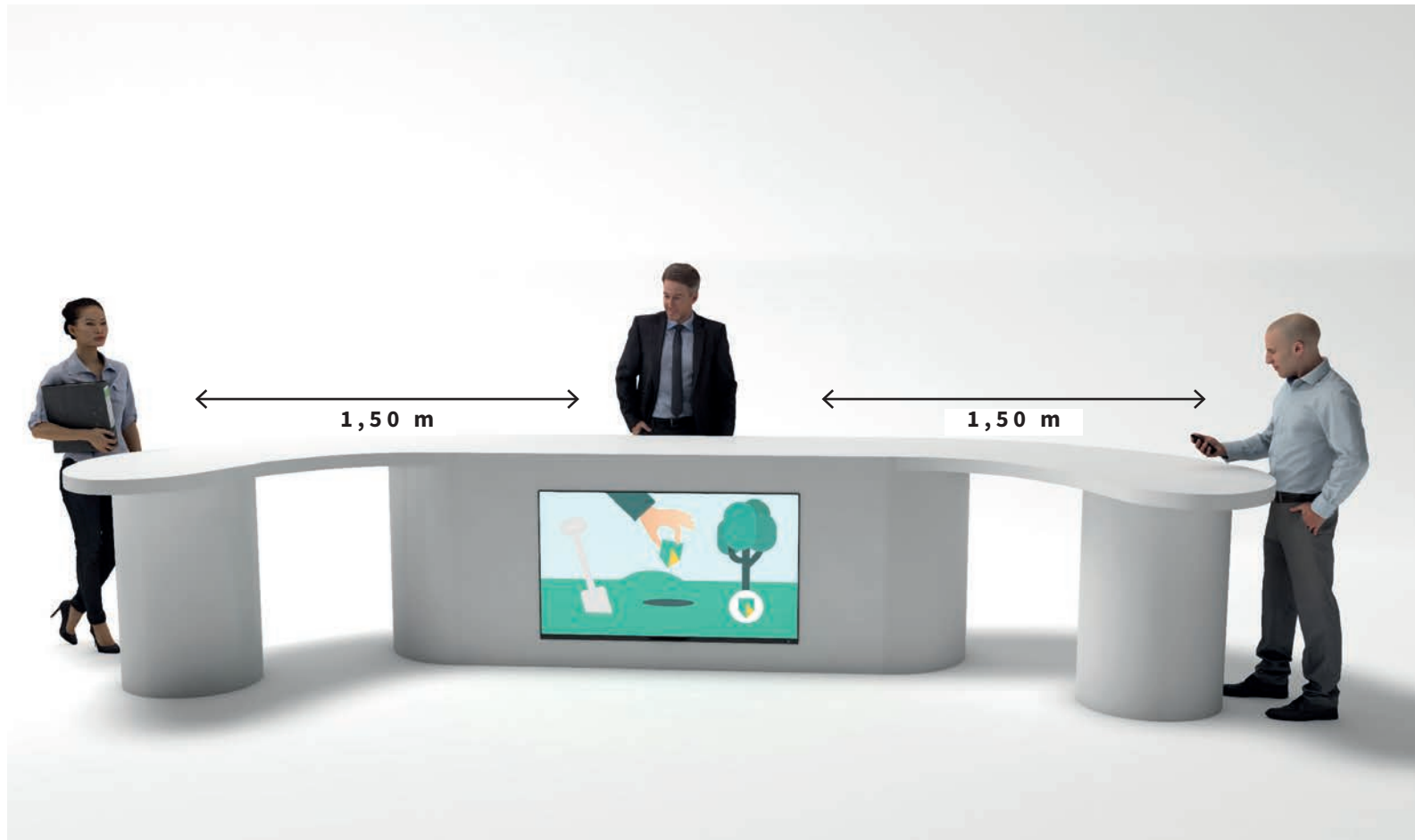

Afstand tussen de personen achter de balie

Studio balie

Optie 2

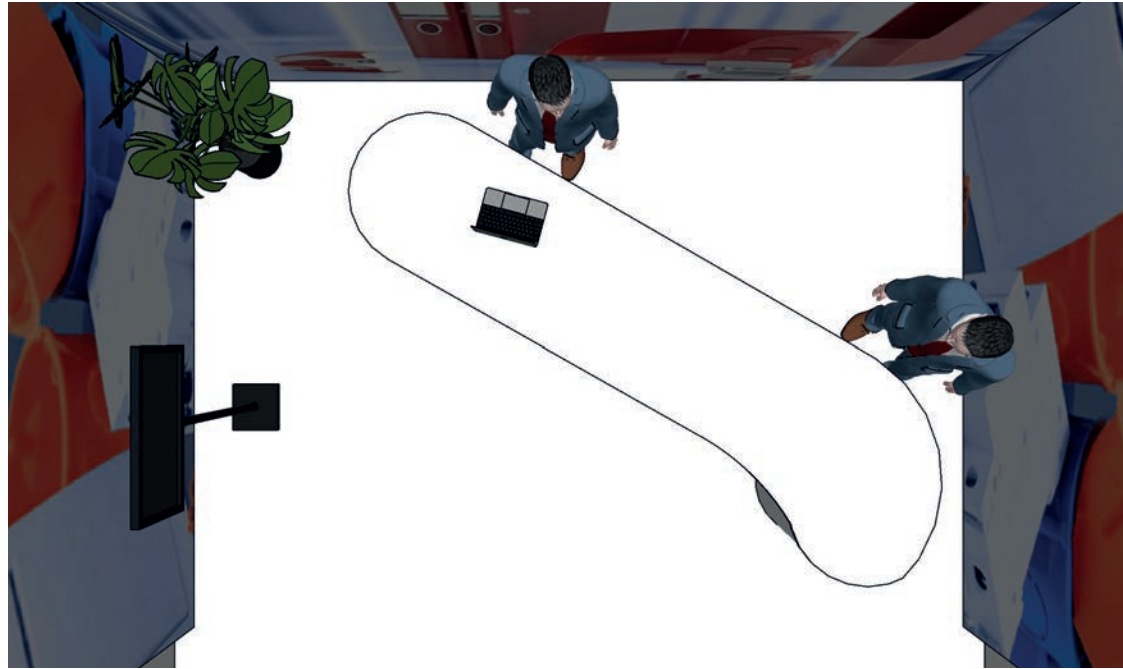

*De studiobalie van **3,00 meter lang** is geschikt voor een gesprek met **max. 2 personen** (in Corona-tijden)*

Studio balie

Optie 2

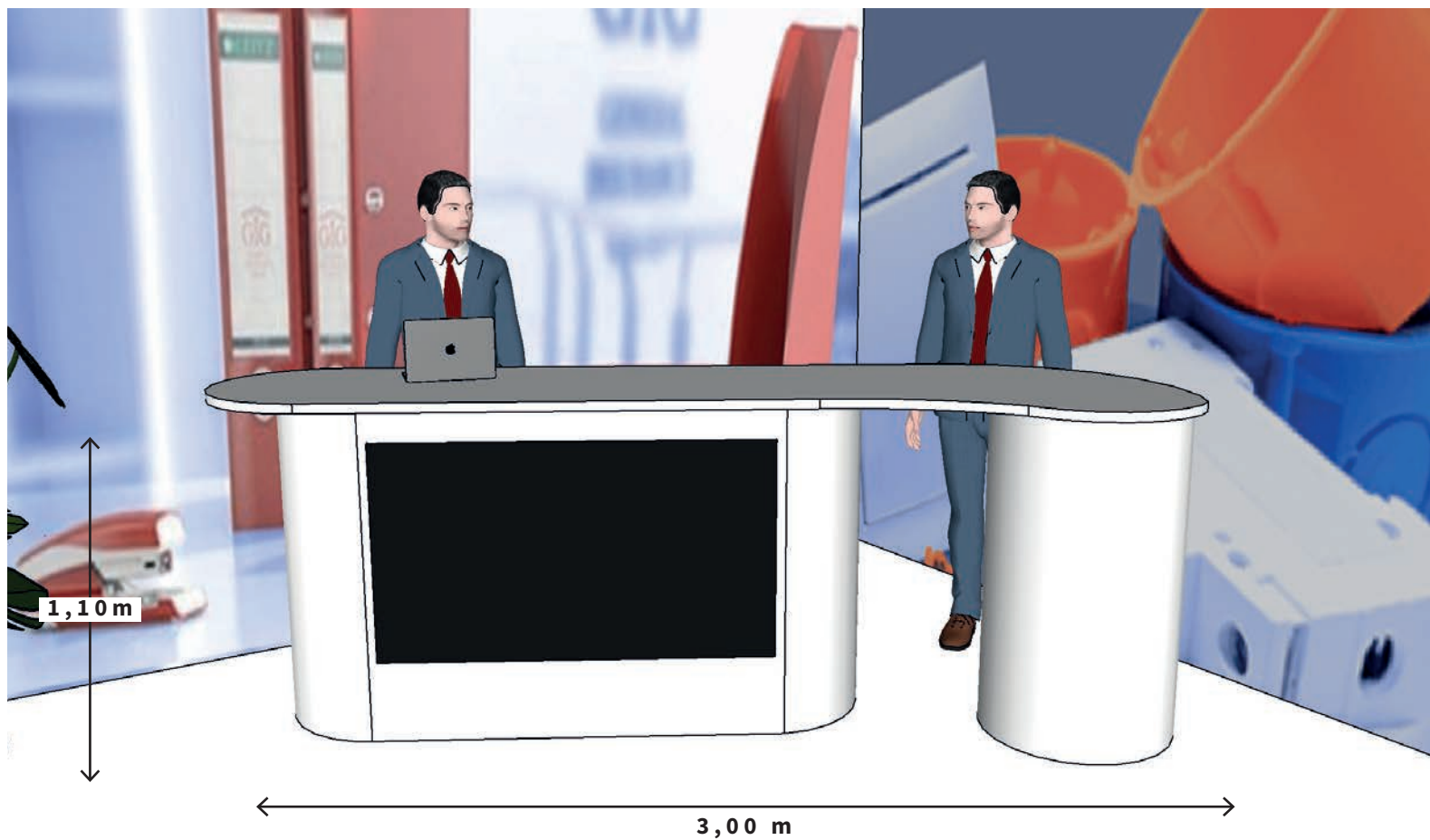

*Maten van de Balie **3,00 meter** breed x **1,10 meter** hoog*

Studio balie

Optie 2

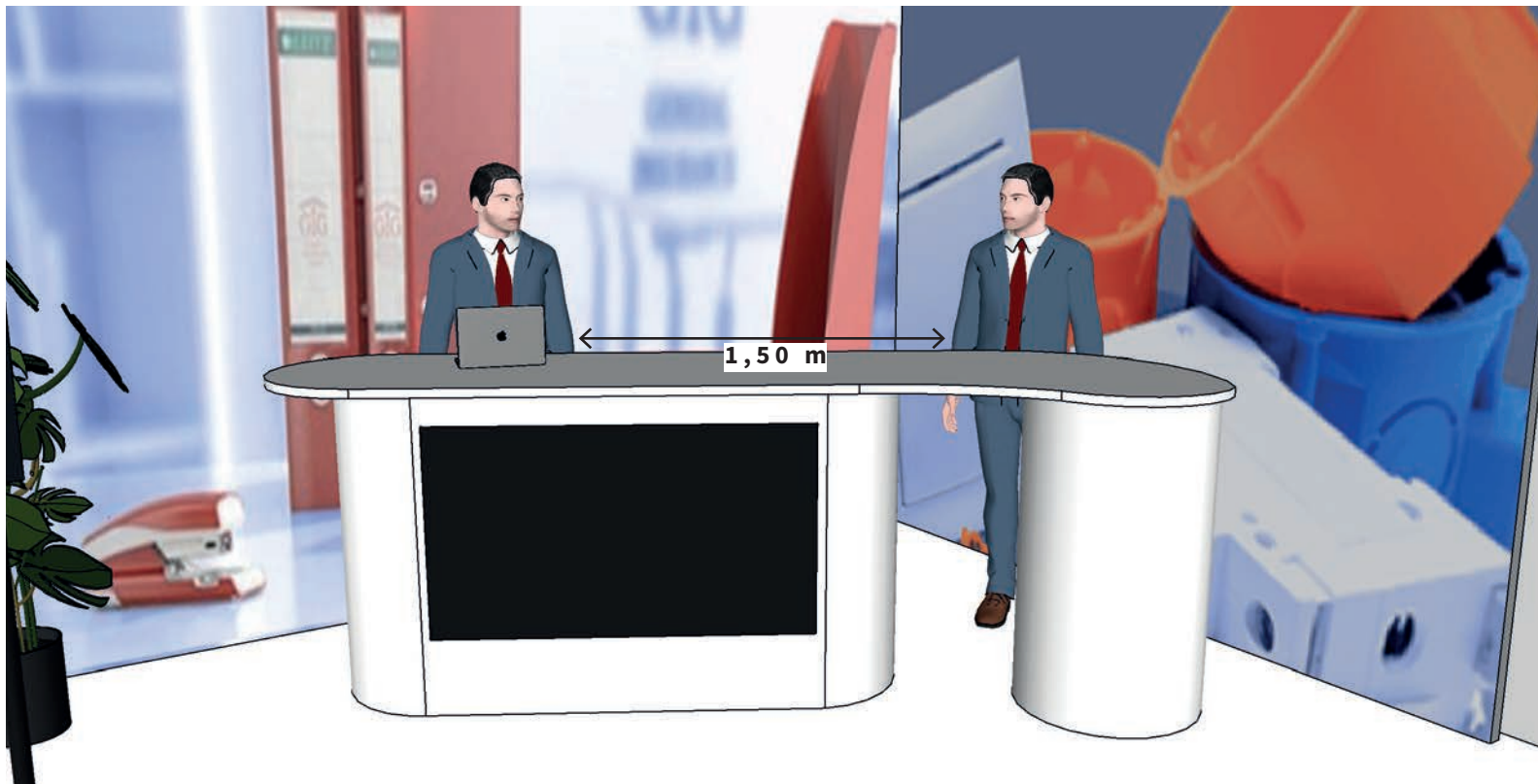

Afstand tussen de personen achter de balie

DECOR INSPIRATIE



Wij kunnen de studio uitbreiden met een podium, achtergrond aankleding, zitjes, stagedesign of op maat gemaakte materialen.

Meerprijs op aanvraag.

DECOR INSPIRATIE

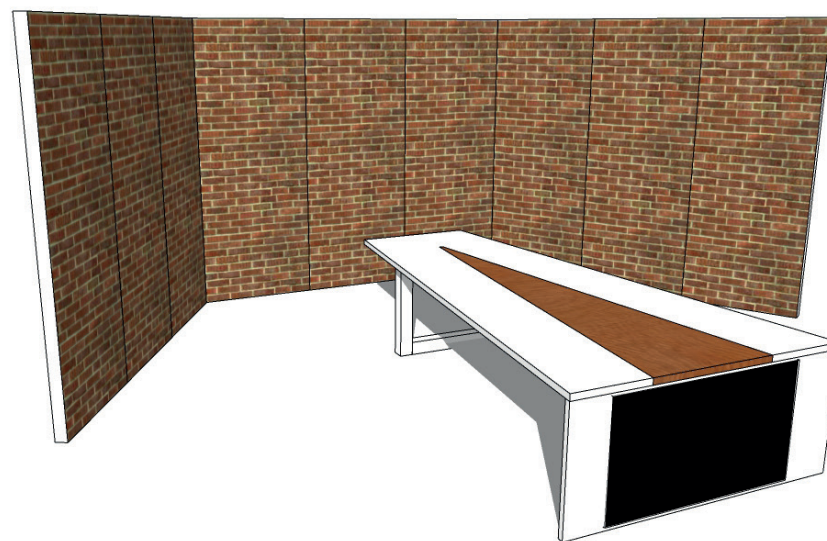
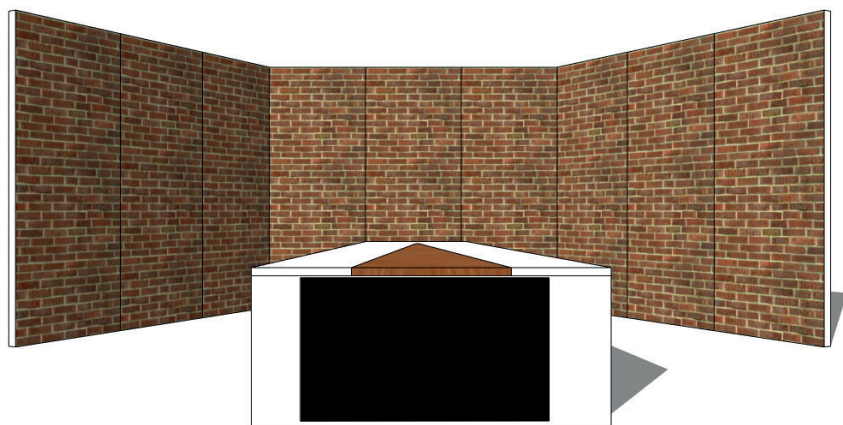

DECOR INSPIRATIE



DECOR INSPIRATIE



VOORBEELD OPTIES MEUBILAIR

Stoelen, krukken en banken



Antraciet leren stoel



Velvet okergeel fauteuil



Witte metalen Tolix stoel



Cognac barkruk in hoogte verstelbaar



Zwarte metalen Tolix barkruk



Oudroze velvet 2-zitsbank



Groene gestoffeerde fauteuil



Velvet roest oranje fauteuil



Zwarte stoel



Piano barkruk



Witte metalen Tolix barkruk



Okergoudgeel velvet 2-zitsbank



Velvet groen fauteuil



Witte kuipstoel



Velvet groen barkruk



Lichtroze bank velvet

Meer opties zijn uiteraard mogelijk in overleg.

TECHNISCHE SPECS

Technische specificaties

- De tafel en de balie worden geleverd met een 55-inch beeldscherm plus afstandsbediening (16x9 verhouding)

- In onze studio tafel en in onze balie zit het beeldscherm ingebouwd. Het is geen optie om een eigen beeldscherm hierin te plaatsen.

- Het beeldscherm heeft een HDMI en een USB-ingang. Zelf adviseren wij om een laptop aan te sluiten en geen USB te gebruiken.

- Er wordt een standaard HDMI-kabel bij geleverd.

- Let op: tafelblad komt in 1 deel van 3,00 of 3,50 meter lang. Wij hebben 2 tafels die geschikt zijn voor normale goederen/personen-liften. Bij twijfel altijd opmeten.

- Opdrachtgever is zelf verantwoordelijk voor het checken van mogelijke liften/doorgangen. Indien blijkt dat de tafel bij levering niet op de plek van bestemming kan aankomen, blijft opdrachtgever 100% aansprakelijk voor het voldaan van de factuur.

- De tafel is zodanig zwaar dat hij niet een verdieping naar boven/beneden getild kan worden. De tafelkar moet ten alle tijden naast de plek van bestemming kunnen komen ivm het (de)monteren van de tafel.

- De balie kan niet in iedere lift, bij twijfel neem contact met ons op!

WAT WIJ NOG MEER DOEN:



Voor meer opties bekijk onze website
<https://teleukeventdesign.nl/>

TE LEUK EVENTDESIGN

————— concept en creatie —————