



Tuinhuizen - Carports - Paardenstallen - Hout - Doe-Het-Zelf - Interieur

Hout- en Bouwmarkt HBM BV | Rode Akkers 3 | 2460 Kasterlee

www.hbm-online.be | T 014 85 32 98 | BTW BE 0738.641.637

HOUT CATALOGUS

**GEÏMPREGNEERD HOUT - DAKTIMMER - ONBEHANDELD HOUT, GESCHAAFD &
RUW - HARDHOUT - GEVELBEKLEDING - CONSTRUCTIEHOUT**



GESCHAAFDE PLANKEN GEÏMPREGNEERD HOUT	3
12 X 1.5 VUREN SCHERMPLANK GESCHAAFD GEÏMPREGNEERD	3
8.2 X 2.8 VUREN SCHERMKEPER GESCHAAFD GEÏMPREGNEERD	3
VUREN CLS GESCHAAFD GEÏMPREGNEERD	3
4.5 X 2.2 GRELEN PLAFONDLAT GESCHAAFD GEÏMPREGNEERD	3
4.5 X 4.5 GRELEN KEPER GESCHAAFD GEÏMPREGNEERD	3
14 X 4.5 GRELEN GORDING GESCHAAFD GEÏMPREGNEERD	3
9 X 2.2 GRELEN PLANK GESCHAAFD GEÏMPREGNEERD	4
14 X 2.5 VUREN TERRASPLANK GESCHAAFD GEÏMPREGNEERD	4
GRELEN BOORDPLANK GESCHAAFD GEÏMPREGNEERD	4
12 X 4.6 GELAMINEERDE GORDING GESCHAAFD GEÏMPREGNEERD	4
TAND GROEF PLANKEN GEÏMPREGNEERD HOUT	4
2.8 X 13.5 VUREN PROFIELPLANK GESCHAAFD GEÏMPREGNEERD	4
3.4 X 13.5 VUREN PROFIELPLANK GESCHAAFD GEÏMPREGNEERD	4
1.8 X 11 VUREN PLANCHÉ GESCHAAFD	4
2.2 X 11 VUREN PLANCHÉ GESCHAAFD	4
2.2 X 13 SIDINGS RUW GEÏMPREGNEERD	4
STEIGERHOUT	5
20 X 3 RUW ONBEHANDELD OF GRIJS GEÏMPREGNEERD	5
BOOMSCHALEN	5
22 MM LARIKS BOOMSCHALEN RUW GEDRENKT	5
VIERKANTE PALEN	5
RONDE PALEN	5
DAKTIMMER	6
22.5 X 7.5 DOUGLAS GORDING RUW ONBEHANDELD	6
RUWE PLANKEN ONBEHANDELD	7
GESCHAAFDE PLANKEN ONBEHANDELD	7
TAND-GROEF PLANKEN ONBEHANDELD	9
GRELEN PLANCHÉ GESCHAAFD ONBEHANDELD	9
HARDHOUT	10
GEVELBEKLEDING	10
PLAATMATERIAAL	11
MDF	11
BETONPLEX	11
MERANTI	11
OSB	12
MELAMINE	12
RADIATA PINE	12
GREEN 1E KEUS	13
POPULIER	13
TRESPA	13
PUBLIPLINT	14
FINEER	14
OREGON	14
GYPROC	14
ISOLATIE	14

12 x 1.5 vuren schermplank geschaafd geïmpregneerd

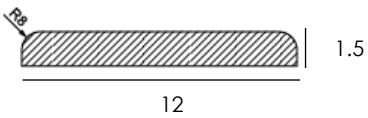

8.2 x 2.8 vuren schermkeper geschaafd geïmpregneerd

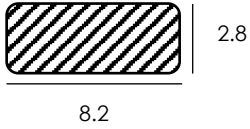

Vuren CLS geschaafd geïmpregneerd

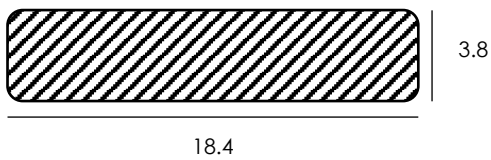
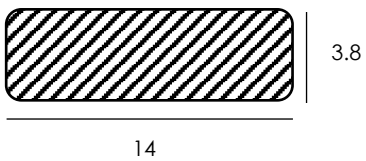
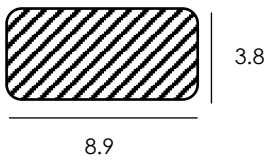
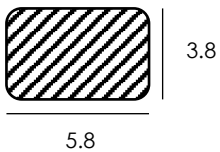

4.5 x 2.2 grenen plafondlat geschaafd geïmpregneerd

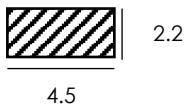

4.5 x 4.5 grenen keper geschaafd geïmpregneerd

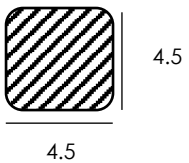

14 x 4.5 grenen gording geschaafd geïmpregneerd

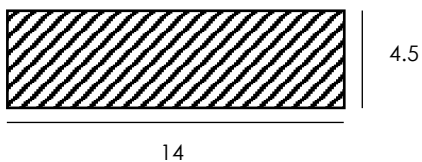

Rechtscherm 180 x 180

Gemaakt met schermplanken
en schermkepers



9 x 2.2 grenen plank geschaafd geïmpregneerd

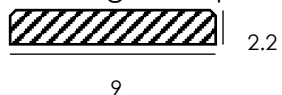

14 x 2.5 vuren terrasplank geschaafd geïmpregneerd

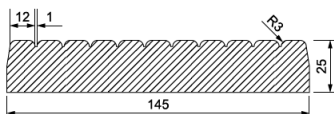

Grenen boordplank geschaafd geïmpregneerd

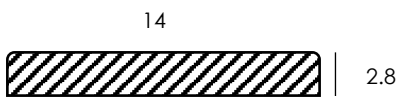

12 x 4.6 gelamineerde gording geschaafd geïmpregneerd

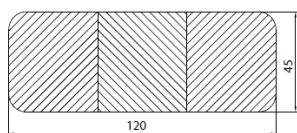

TAND GROEF PLANKEN GEÏMPREGNEERD HOUT

2.8 x 13.5 vuren profielplank geschaafd geïmpregneerd

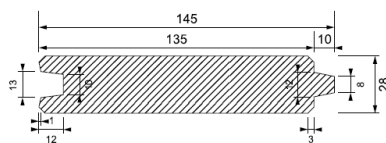

3.4 x 13.5 vuren profielplank geschaafd geïmpregneerd

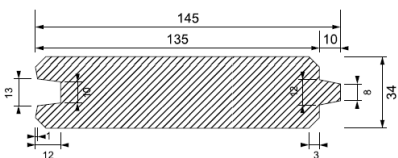

1.8 x 11 vuren planché geschaafd

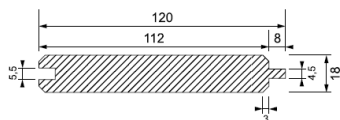

2.2 x 11 vuren planché geschaafd

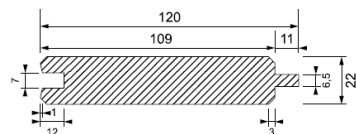

2.2 x 13 sidings ruw geïmpregneerd

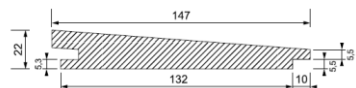

STEIGERHOUT

20 x 3 row onbehandeld of grijs geïmpregneerd

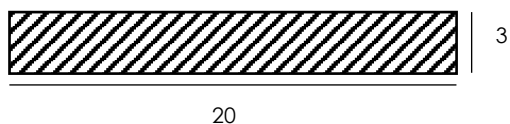

BOOMSCHALEN

22 mm lariks boomschalen row gedrenkt



VIERKANTE PALEN

Geschaafd en geïmpregneerd

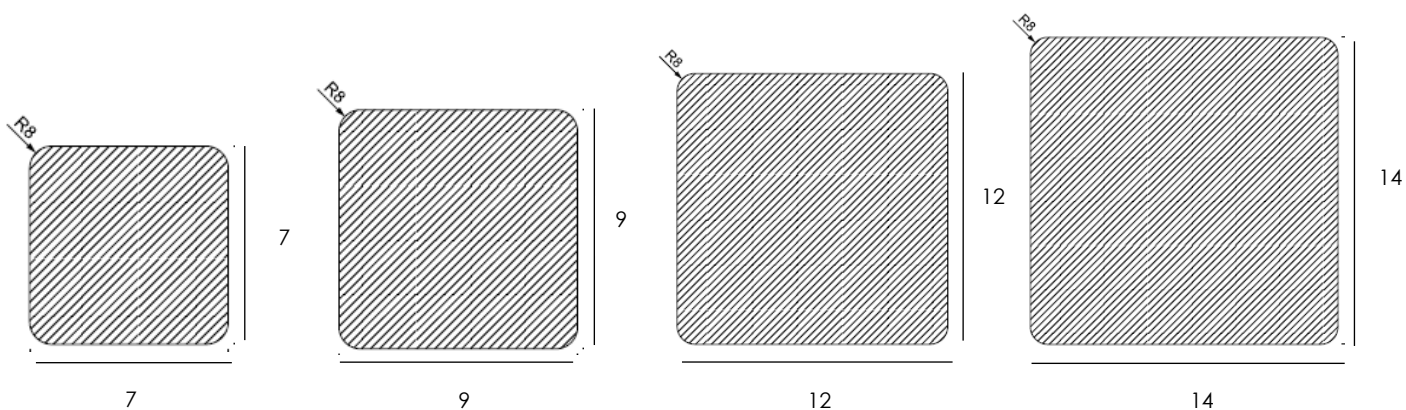

RONDE PALEN

Gefreesd en geïmpregneerd

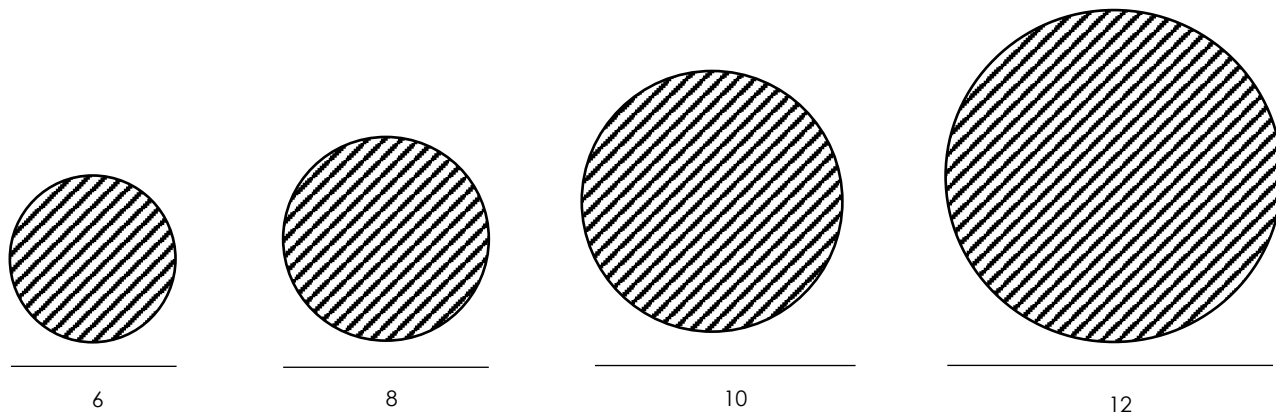

DAKTIMMER

22.5 x 7.5 Douglas gording ruw onbehandeld

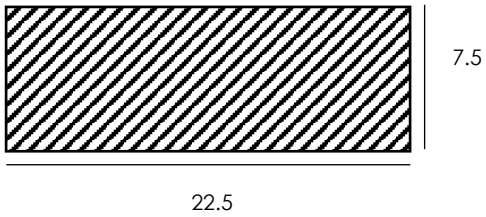

17.5 x 6.3 Douglas gording ruw onbehandeld

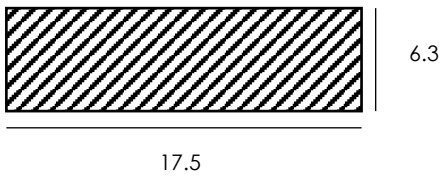

15 x 6.3 Douglas gording ruw onbehandeld

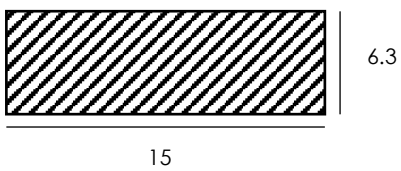

7.3 x 6.3 Douglas gording ruw onbehandeld

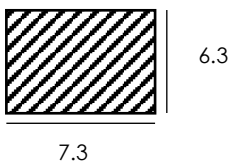

17.5 x 3.8 Douglas spant ruw onbehandeld

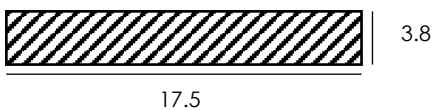

22.5 x 3.8 Douglas spant ruw onbehandeld

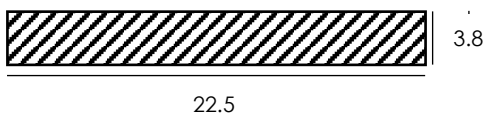

3.8 x 2.4 vuren panlat gedrenkt



3.2 x 1.6 vuren tengellat gedrenkt

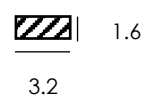

RUWE PLANKEN ONBEHANDELD

10 x 2.5 grenen plank ruw onbehandeld

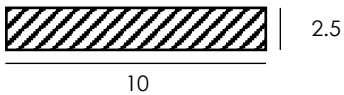

12.5 x 2.5 grenen plank ruw onbehandeld

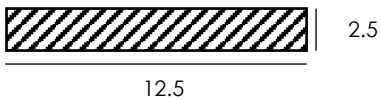

15 x 2.5 grenen plank ruw onbehandeld

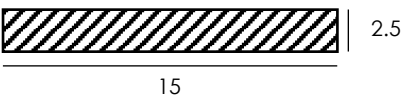

17.5 x 2.5 grenen plank ruw onbehandeld

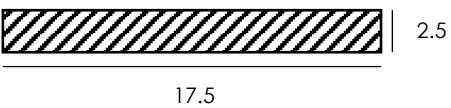

20 x 2.5 grenen plank ruw onbehandeld



GESCHAAFDE PLANKEN ONBEHANDELD

4.5 x 2.2 grenen plank geschaafd onbehandeld

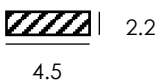

9 x 2.2 grenen plank geschaafd onbehandeld

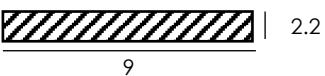

11.5 x 2.2 grenen plank geschaafd onbehandeld

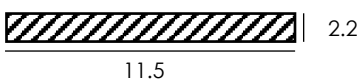

14 x 2.2 grenen plank geschaafd onbehandeld

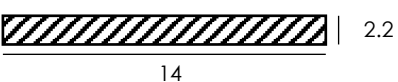

16 x 2.2 grenen plank geschaafd onbehandeld



19 x 2.2 grenen plank geschaafd onbehandeld

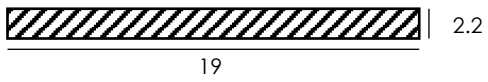

Vuren CLS geschaafd onbehandeld

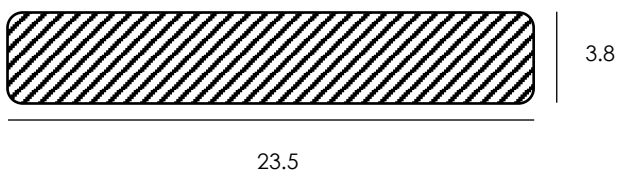
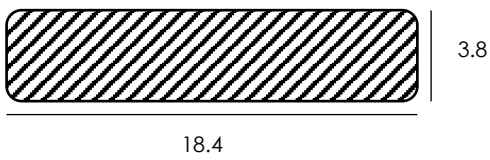
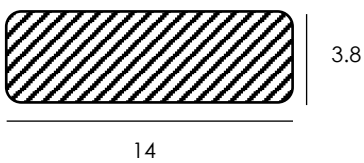
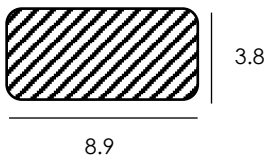
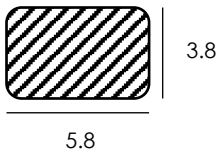

14 x 4.5 grenen gording geschaafd onbehandeld

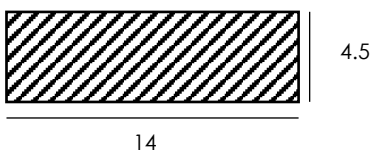

16 x 5.5 grenen gording geschaafd onbehandeld

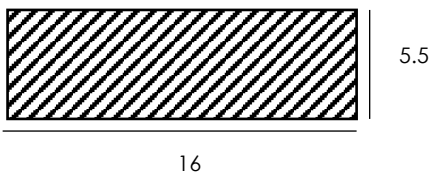

Grenen boordplank geschaafd onbehandeld

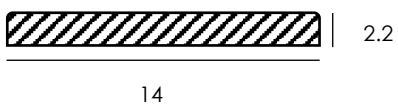

TAND-GROEF PLANKEN ONBEHANDELD

Grenen planché geschaafd onbehandeld

1.2 x 8.5 grenen planché geschaafd onbehandeld

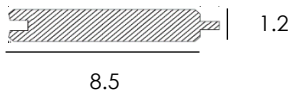

1.5 x 11 grenen planché geschaafd onbehandeld

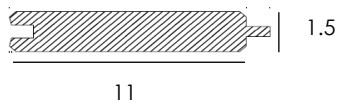

2.2 x 11 grenen planché geschaafd onbehandeld

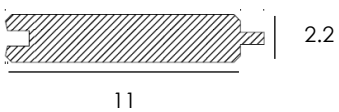

2.8 x 13.5 grenen profielplank geschaafd onbehandeld

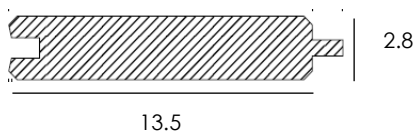

3.4 x 13.5 grenen profielplank geschaafd onbehandeld

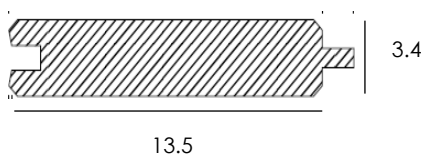

4.5 x 13.5 grenen profielplank geschaafd onbehandeld

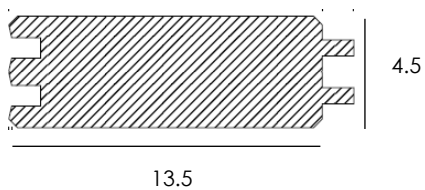

HARDHOUT

Azobe matten breedte: 20 cm, 30 cm, 40 cm, 50 cm, 60 cm, 80 cm

Azobe palen: 4 x 4, 6 x 6, 7 x 7, 12 x 12

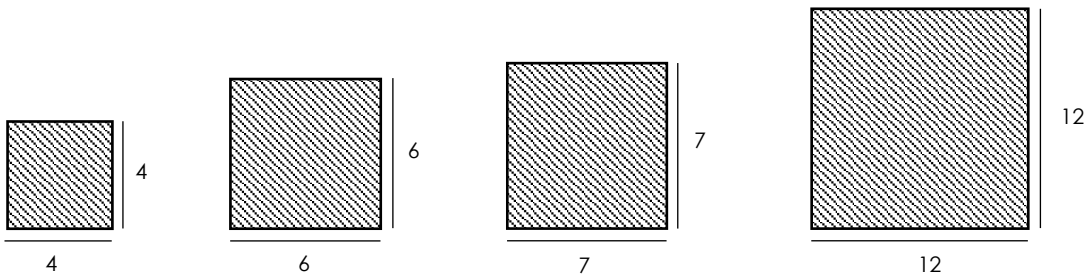

Hardhouten onderlegger 6 x 4

Terrasplanken:

Massaranduba (bankirai) 14 x 2.5

Cumaru B-fix 14 x 2.1

Bankirai palen 8.5 x 8.5

Bankirai kepers 4.5 x 6.0 of 4.0 x 6.0 gelamineerd?



GEVELBEKLEDING

Thermowood Ayous Planché 1.5 x 13cm

Thermowood Ayous Triple gegroefd 2.5 x 13cm

Thermowood vuren planché 18 x 130mm

Ceder planché 1.8 x 13.5cm



Thermowood vuren planché Thermowood Ayous planché

Thermowood Ayous
Triple gegroefd

MDF

- MDF 244 x 122 – 6 mm, 10 mm, 12 mm, 15 mm, 18 mm, 22 mm, 38 mm
- MDF Watervast 244 x 122 – 12 mm & 18 mm
- MDF Watervast 305 x 122 – 12 mm & 18mm
- MDF Watervast + grundierlak 305 x 122 – 18 mm

**BETONPLEX**

- Betonplex Indonesisch 250 x 125 – 3.6 mm, 9 mm, 12 mm, 18 mm
- Betonplex Indonesisch 300 x 150 – 12 mm, 18 mm
- Betonplex Chinees 250 x 125 – 18 mm
- Betonplex Antislip 250 x 125 – 18 mm

**MERANTI**

- Meranti 244 x 122 – 3.6 mm, 5 mm, 8 mm, 12 mm, 15 mm, 18 mm, 22 mm
- Meranti gegroefd 244 x 122 – 12mm



GREEN 1e keus
244 x 122 – 12 mm, 18 mm



POPULIER
244 x 122 – 3.6 mm, 18 mm



TRESPA

- Wit 305 x 130 – 6 mm
- Zwart 305 x 130 – 6 mm

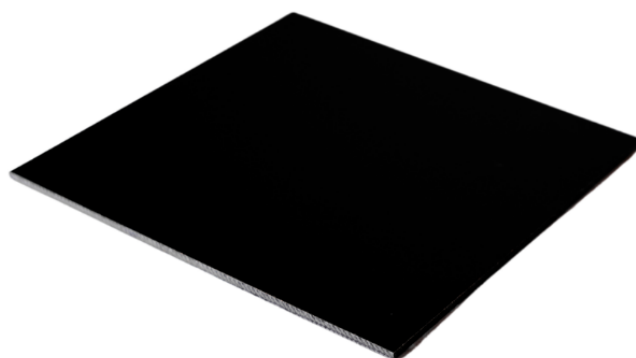
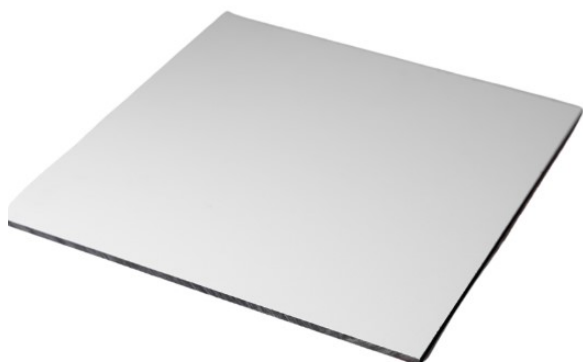

PUBLIPLINT

250 x 125 – 9 mm, 12 mm

FINEER

EIK 244 x 122 – 4 mm, 18 mm

BEUK 244 x 122 – 4 mm, 18 mm

OREGON

- 244 x 122 – 9 mm, 12 mm, 18 mm

GYPROC

260 x 60 – 9.5 mm

260 x 120 – 9.5 mm, 12.5 mm

Watervast 260 x 60 – 12.5 mm

Watervast 260 x 120 – 12.5 mm



ISOLATIE

XPS spouwplaat Ursa – 2cm, 3cm, 4cm, 5cm, 6cm

Acoustifit glaswolmat – 5cm & 9cm

Glaswol Knauf Multifit – 10cm, 12cm, 14cm, 15cm, 18cm



INDIEN U GRAAG MEER INFO HEEFT OVER ONZE LENGTE MATEN EN
PRIJZEN MAG U STEEDS EEN MAIL STUREN NAAR [INFO@HBM-
ONLINE.BE](mailto:INFO@HBM-ONLINE.BE).

OOK BESTELLINGEN VOOR ZAAGWERK MAG U DOORMAILLEN NAAR
BOVENSTAAND MAILADRES.