

INSIDE FRAME PROFILES

For a full list of frame and panel combination drawings, along with door size minimum specs, print our new "Door Coding and Specs" sheet from our website!

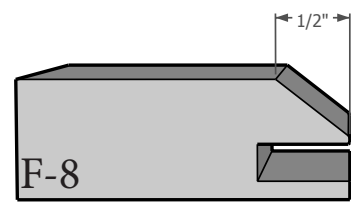
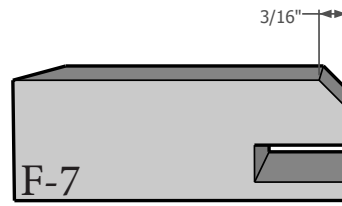
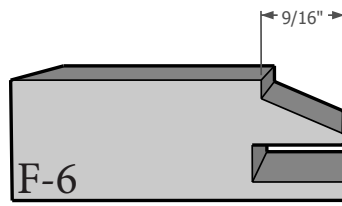
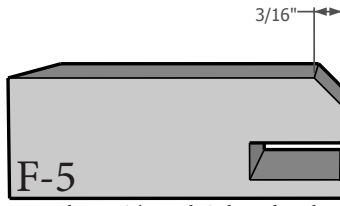
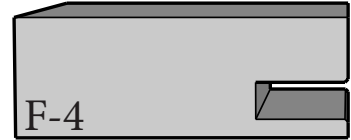
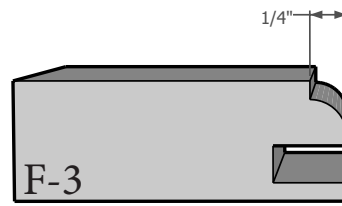
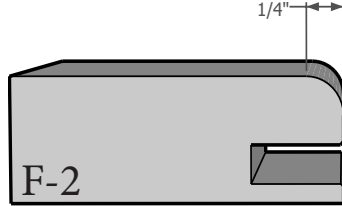
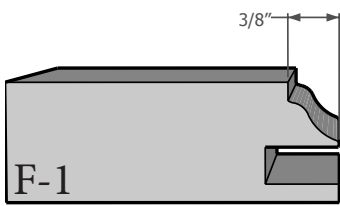

Bevel Runs Through Stile and Rail Joint

Bevel Does Not Run Through Stile and Rail Joint

PANEL PROFILES

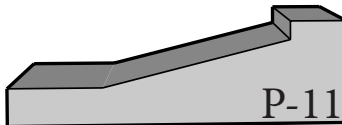
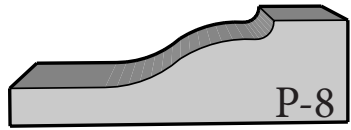
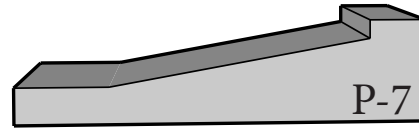
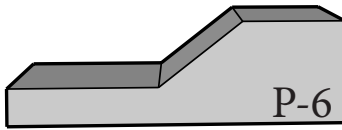
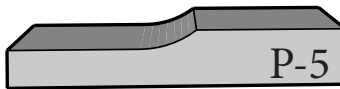
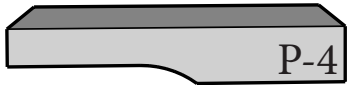
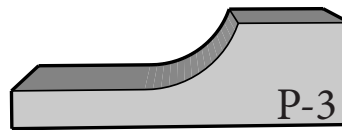
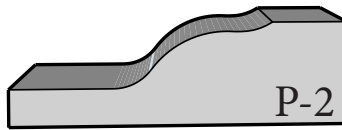
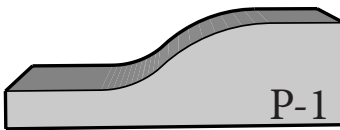

OUTSIDE EDGE PROFILES

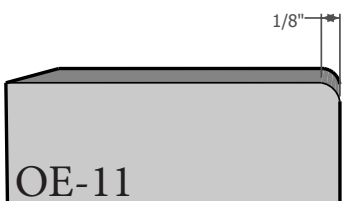
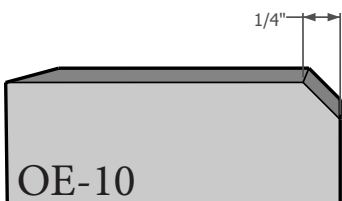
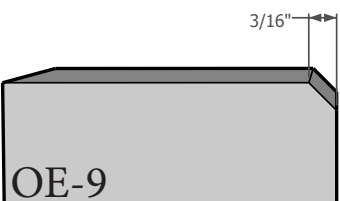
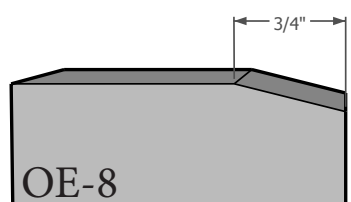
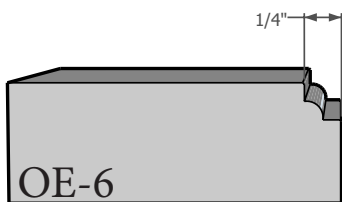
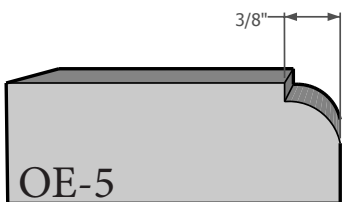
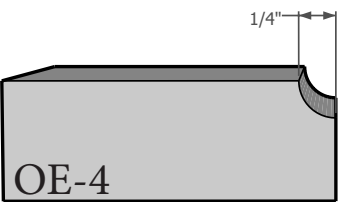
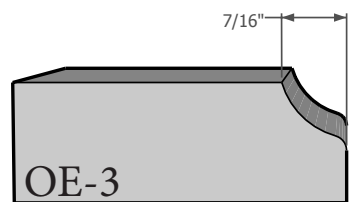
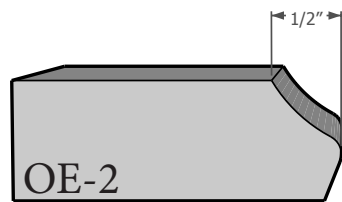
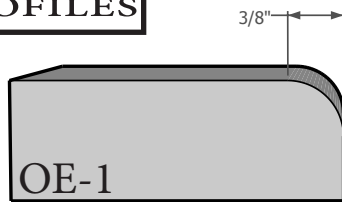
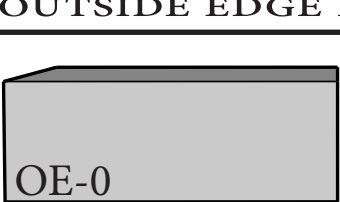

For a full list of frame and panel combination drawings, along with door size minimum specs, print our new “Door Coding and Specs” sheet from our website!

JOINT VISUAL FOR F-5 // F-7

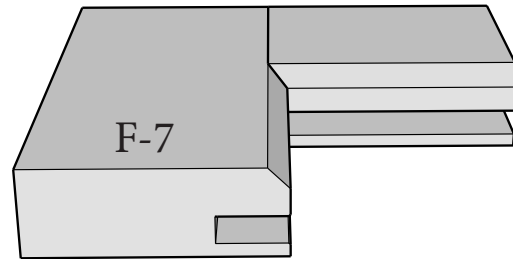
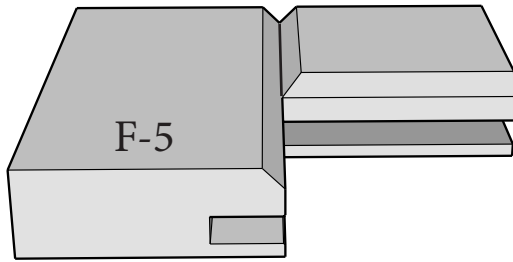

PLYWOOD DOOR CODING

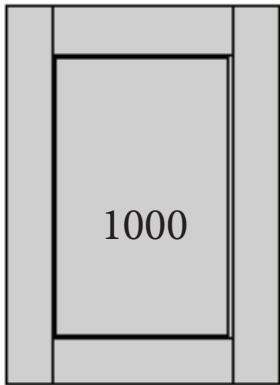

Plywood Square Door

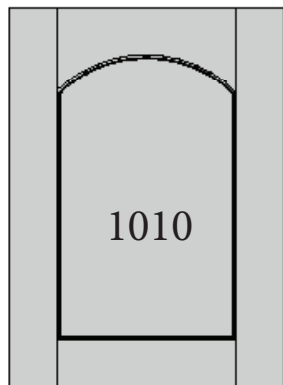

Plywood “Eyebrow”
Curve Door

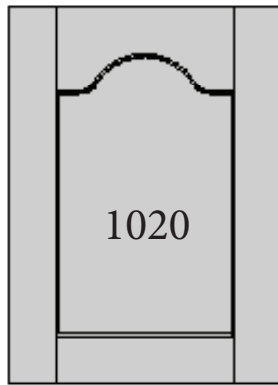

Plywood “Cathedral”
Curve Door

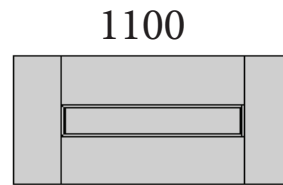

Plywood Square
Drawer Front



Slab Drawer Front

SOLID DOOR CODING

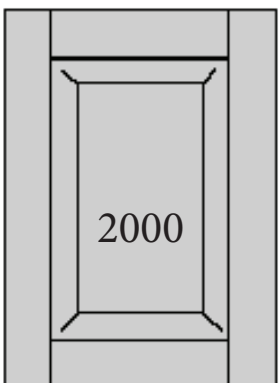

Solid Square Door



Solid “Eyebrow”
Curve Door

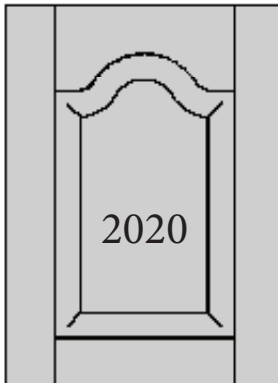

Solid “Cathedral”
Curve Door

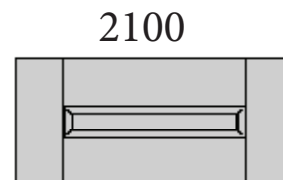

Solid Square
Drawer Front



Slab Drawer Front

**MITRE FRAMES AND OTHER
SPECIALTY ITEMS**

MITRE FRAMES FRAME SIZES AVAILABLE IN 1 1/2" 2 1/4" 3"

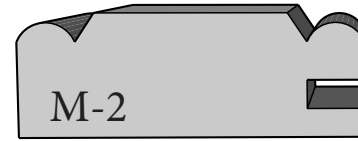

CROWN MOULDINGS

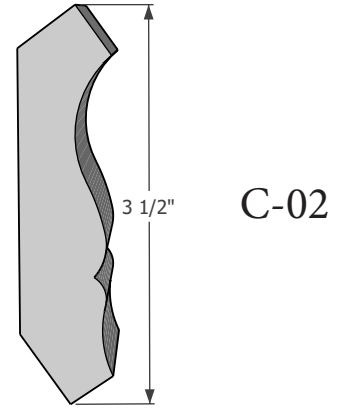
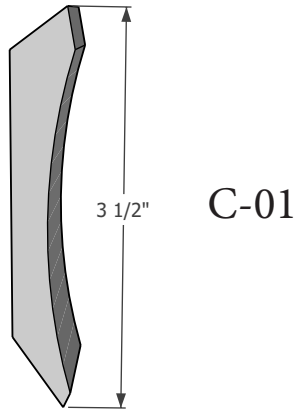

We are also a distributor for Classic Mouldings in Calgary, Alberta. If you would like other mouldings shipped with your door order, place your order with us and we will batch your shipments together

BUTCHER BLOCKS

Standard plank width for butcher block tops are 3/4"

For a full list of frame and panel combination drawings, along with door size minimum specs, print our new "Door Coding and Specs" sheet from our website!