

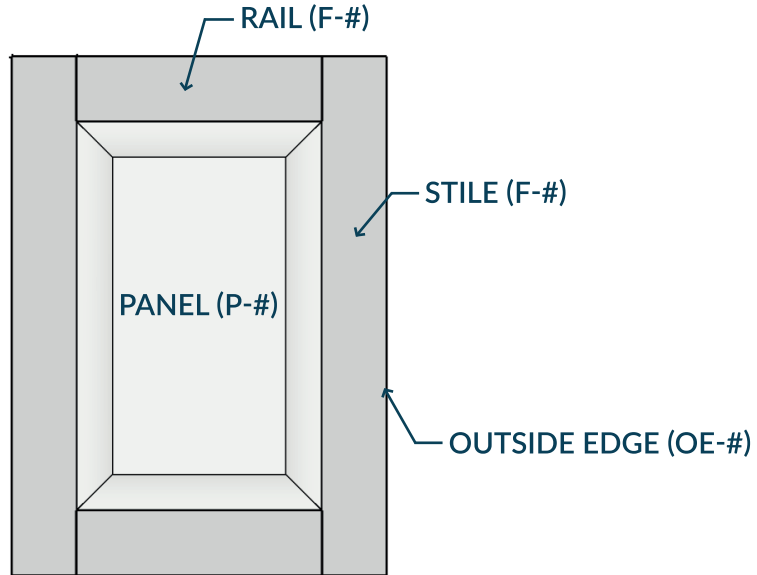

# DOORS

## TO ORDER

\*For a door order form, visit <https://klaas.ca/doors>  
Email your order form to [sales@klaas.ca](mailto:sales@klaas.ca)



For a full list of frame and panel combination drawings, along with door size minimum specs, view our “Door Coding and Specs” sheet on our website. <https://klaas.ca/doors>

## MATERIALS

### PAINT GRADE

#### MDF

All MDF Doors are made as 5-piece.  
1 and 2 piece doors are unavailable.

#### Maple Hybrid

A combination of Maple frame and MDF center panel.

### CLEAR GRADE

Maple  
Alder  
Beech  
Birch  
Black Walnut  
Cherry  
Hickory  
Oak - Red  
Oak - White  
Oak - Quarter Cut White  
Oak - Rift Cut White  
Vertical Grain Fir

### RUSTIC/KNOTTY

Alder - Knotty  
Black Walnut - Rustic  
Cherry - Rustic  
Hickory - Rustic  
Pine - Knotty  
White Oak - Rustic

## INSIDE FRAME PROFILES

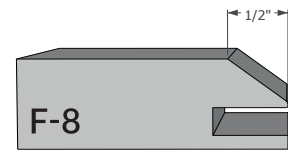
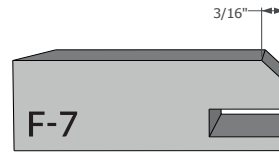
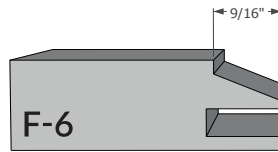
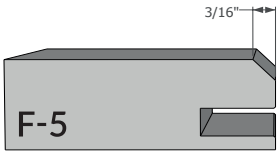
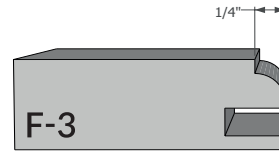
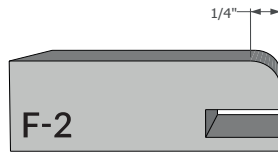
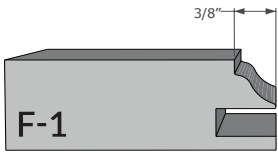

Bevel runs through stile and rail joint

Bevel does not run through stile and rail joint



## PANEL PROFILES

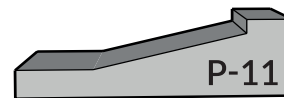
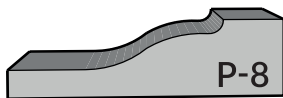
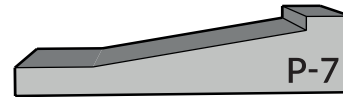
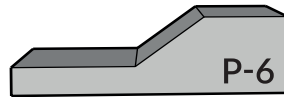
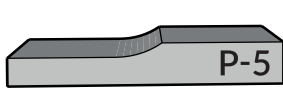
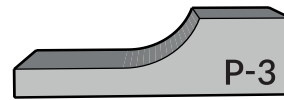
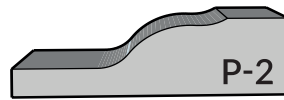
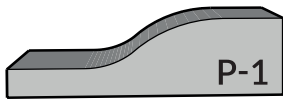

## OUTSIDE EDGE PROFILES

