



IN THE EVENT THAT FIXTURE LOCATIONS NEED TO CHANGE, PLEASE CHECK WITH SKYTRON ON THE REVISED LAYOUT LOCATION. FINAL CONSTRUCTION DOCUMENTS SHOULD BE PROVIDED BY THE ARCHITECT.



**\*GENERIC LAYOUT\***

EQUIPMENT SCHEDULE	
ID	DESCRIPTION
A	ANESTHESIA
B	DISPLAY / DISPLAY / DUAL LIGHTS
C	EQUIPMENT / DISPLAY
* IF SKYVISION IS APPLICABLE REFER TO THE LAST PORTION OF BOOM PACKAGE*	

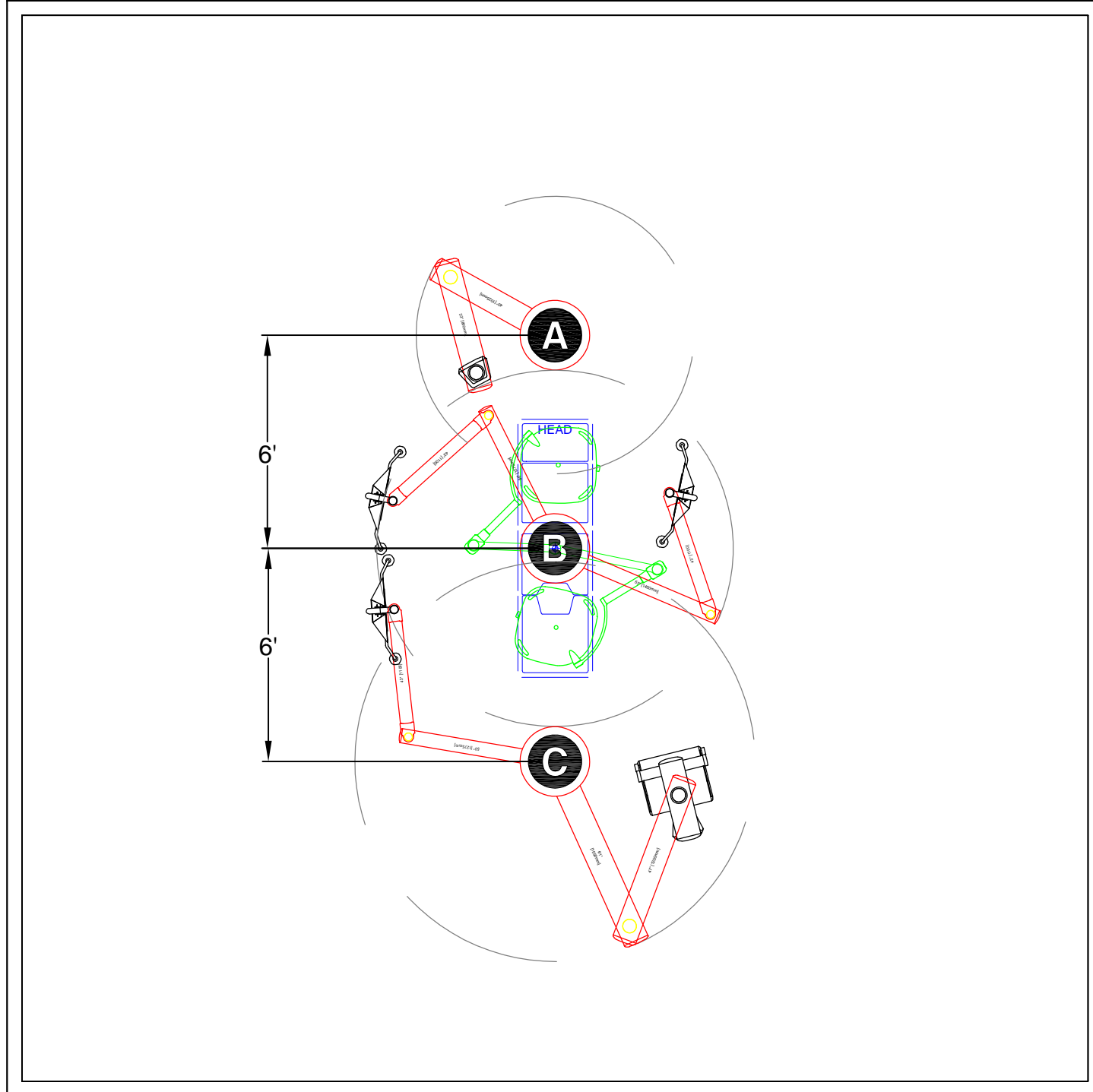

INITIAL: \_\_\_\_\_  
DATE: \_\_\_\_\_

PROJECT #: 21-000  
PRELIMINARY  
PLOT DATE: 9/08/2021

ROOM TYPE: ORTHO  
DESCRIPTION: ROOM LAYOUT

REV #: 0

SHEET  
**00**

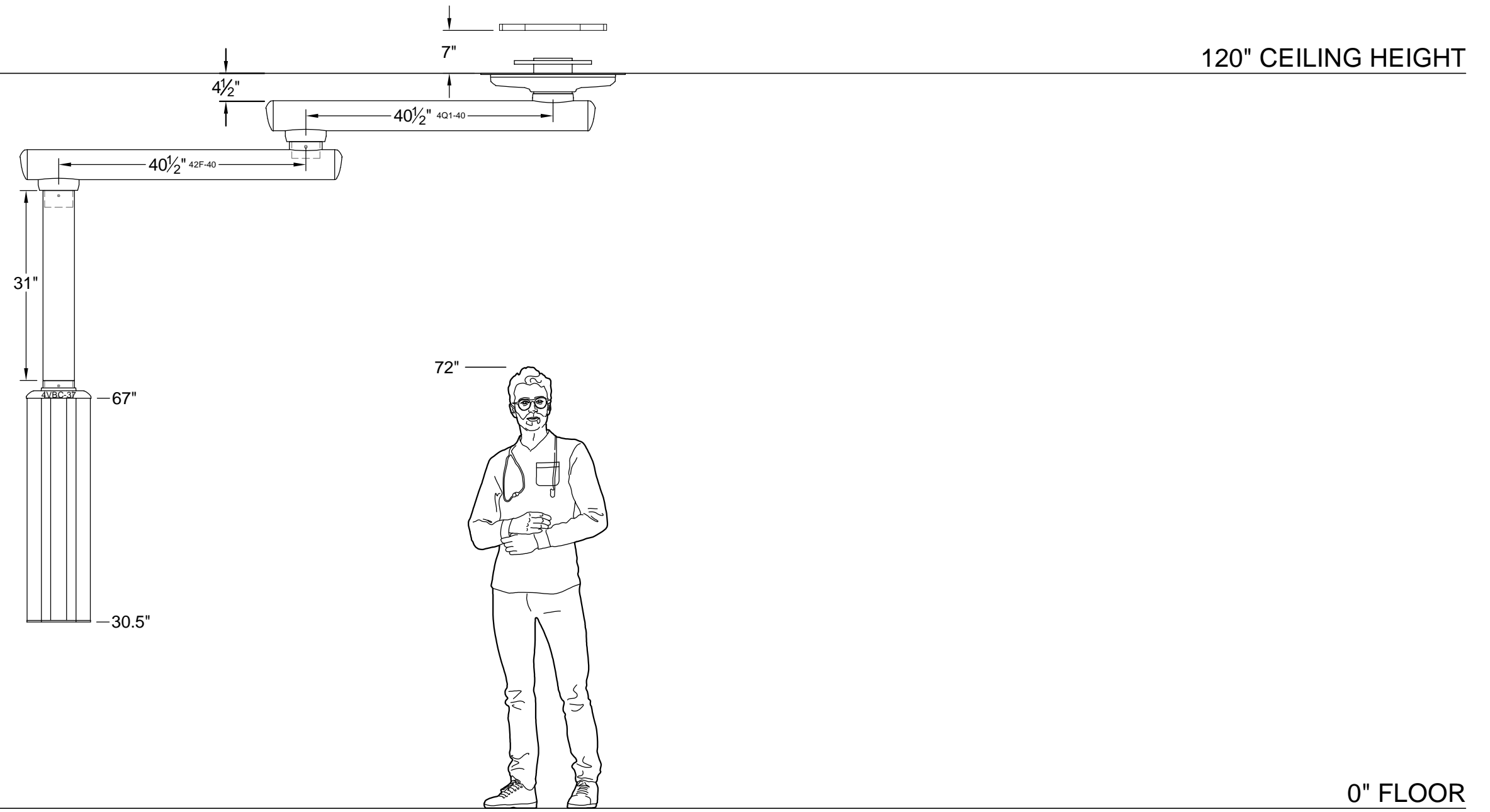

ORTHO

INITIAL: \_\_\_\_\_  
DATE: \_\_\_\_\_

**Max Fixture Weight:** 538 lbs.  
**Max Moment Load:** 2,581 ft. lbs.

**Equipment Capacity:** 4VBC-37 - 241 lbs.

REF #: C-70775  
MODEL: F200 SERIES  
DESCRIPTION: ELEVATION DETAILS

QTY: 1  
REV #: 0

SHEET  
**A1**

Note:  
Communications can only  
be placed above the  
top-most separator plate

FRONT-LEFT VIEW

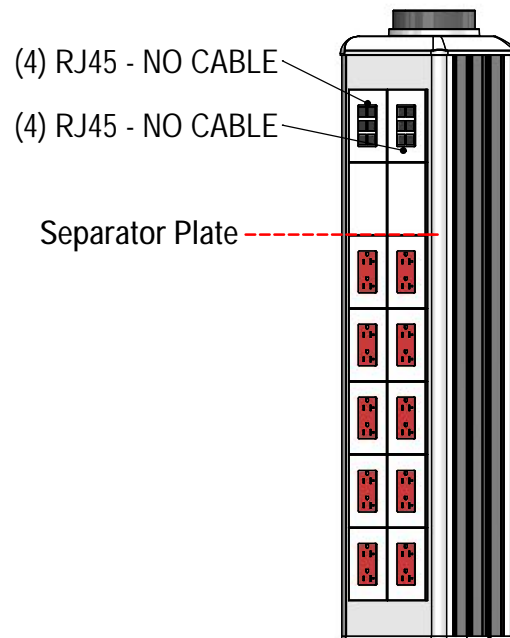

FRONT-RIGHT VIEW

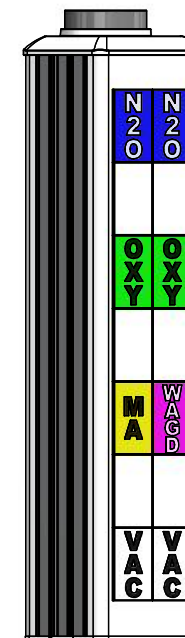

DESCRIPTION	QTY.
NITROUS OXIDE	2
OXYGEN	2
MEDICAL AIR	1
WAGD	1
VACUUM	2

ELECTRICAL OUTLETS: (10) 125V, 20A DUPLEX - RED

GAS FACEPLATE STYLE: DISS

CARRIER DIMENSIONS: 37.75"H x 16.75"W x 8.25"D

GAS COLOR KEY:

CARBON DIOXIDE	MEDICAL AIR	OXYGEN
HELIOX	NITROGEN	VACUUM
INSTRUMENT AIR	NITROUS OXIDE	WAGD

INITIAL: \_\_\_\_\_  
DATE: \_\_\_\_\_

FOR A COMPLETE LIST OF ACCESSORIES  
REFER TO YOUR QUOTE

PROJECT #: 21-000  
PRELIMINARY  
PLOT DATE: 9/8/2021

ORTHO

QTY: 1  
REV #: 0  
REF #: C-70775  
MODEL: F200 SERIES  
DESCRIPTION: CARRIER DETAILS

SHEET  
**A2**

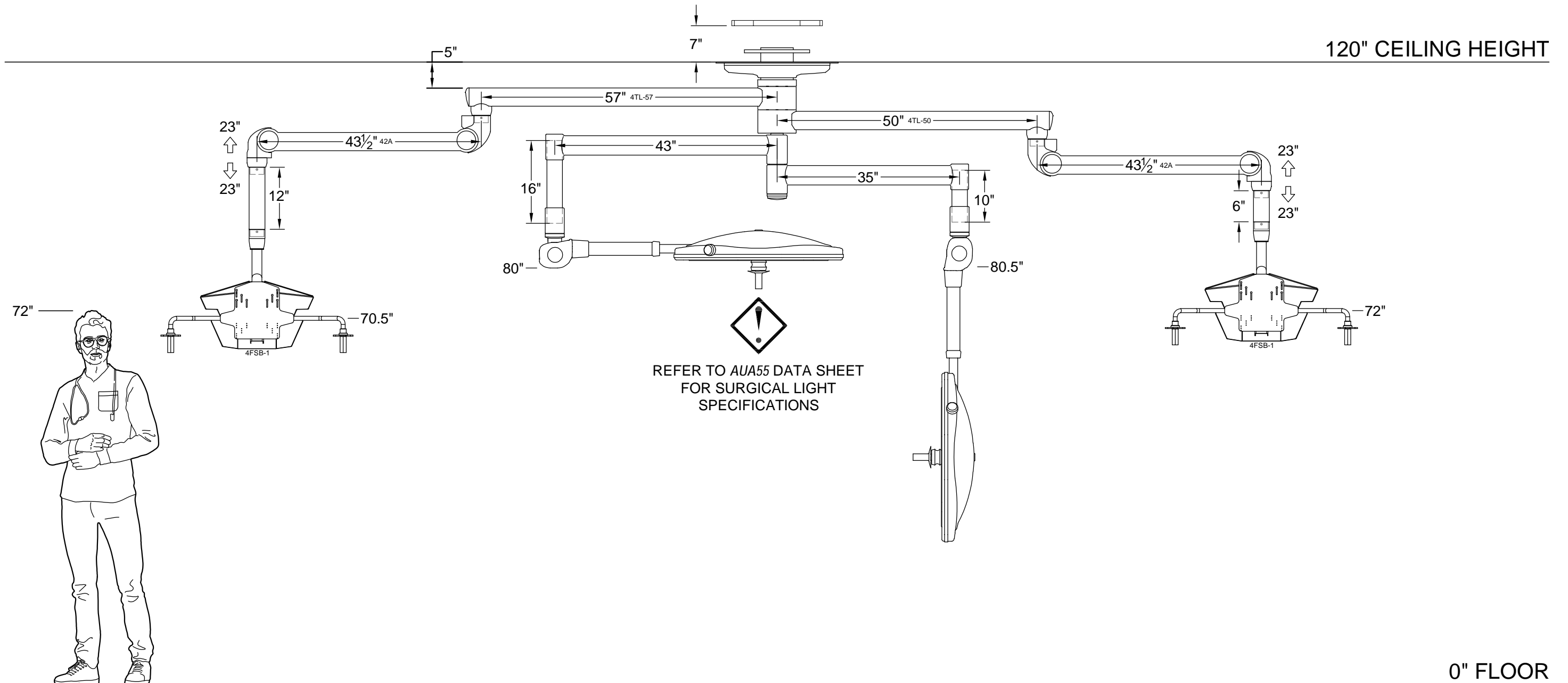

**ORTHO**

INITIAL: \_\_\_\_\_  
DATE: \_\_\_\_\_

**Max Fixture Weight:** 723 lbs.  
**Max Moment Load:** 3,953 ft. lbs.

**Equipment Capacity:** U. 4FSB-1 - 37 lbs.  
L. 4FSB-1 - 39 lbs.

REF #: C-69326  
MODEL: F120 SERIES  
DESCRIPTION: ELEVATION DETAILS

QTY: 1  
REV #: 0

SHEET  
**B1**

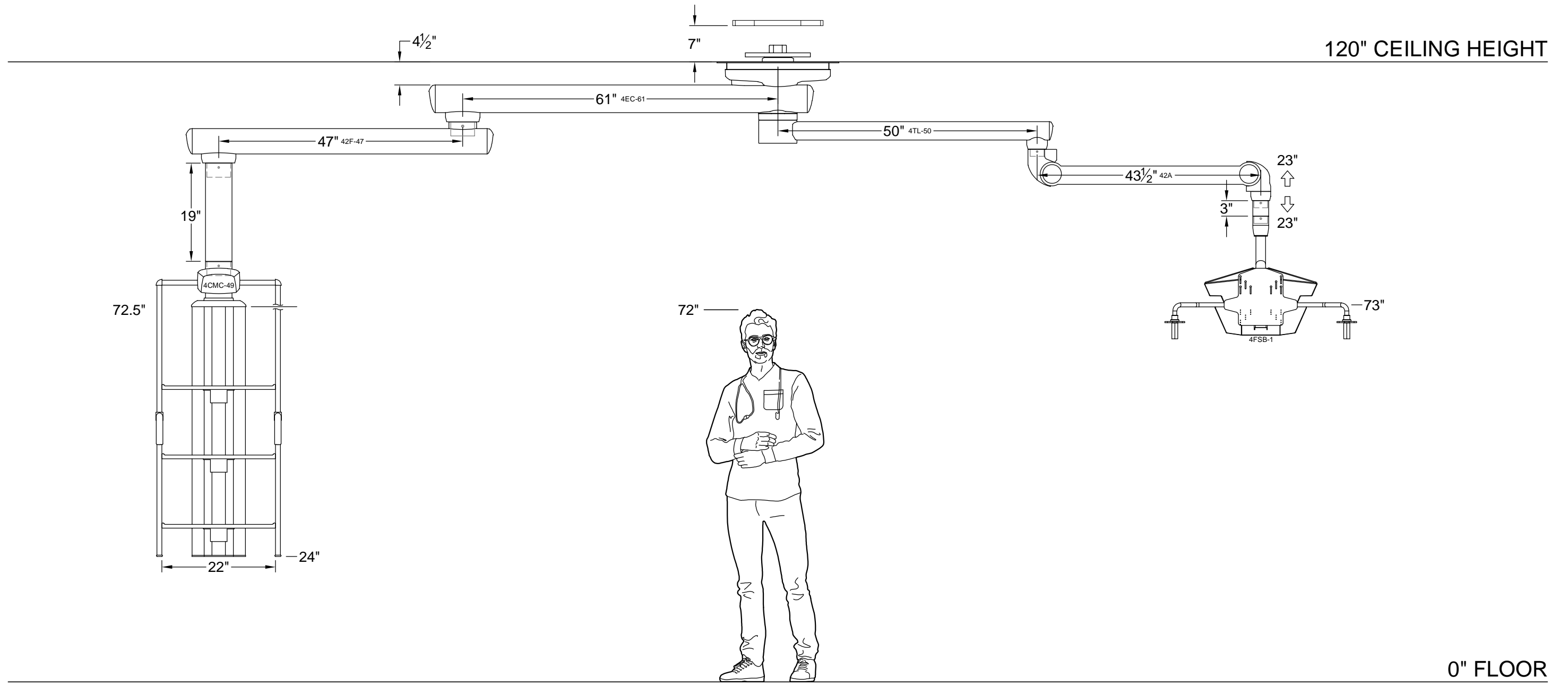

**ORTHO**

INITIAL: \_\_\_\_\_  
DATE: \_\_\_\_\_

**Max Fixture Weight:** 1,188 lbs.  
**Max Moment Load:** 6,922 ft. lbs.

**Equipment Capacity:** 4CMC-49 - 183 lbs.  
4FSB-1 - 40 lbs.

REF #: C-70840  
MODEL: F320 SERIES  
DESCRIPTION: ELEVATION DETAILS

QTY: 1  
REV #: 0

SHEET  
**C1**

FRONT-LEFT VIEW

FRONT-RIGHT VIEW

Note:  
Communications can only  
be placed above the  
top-most separator plate

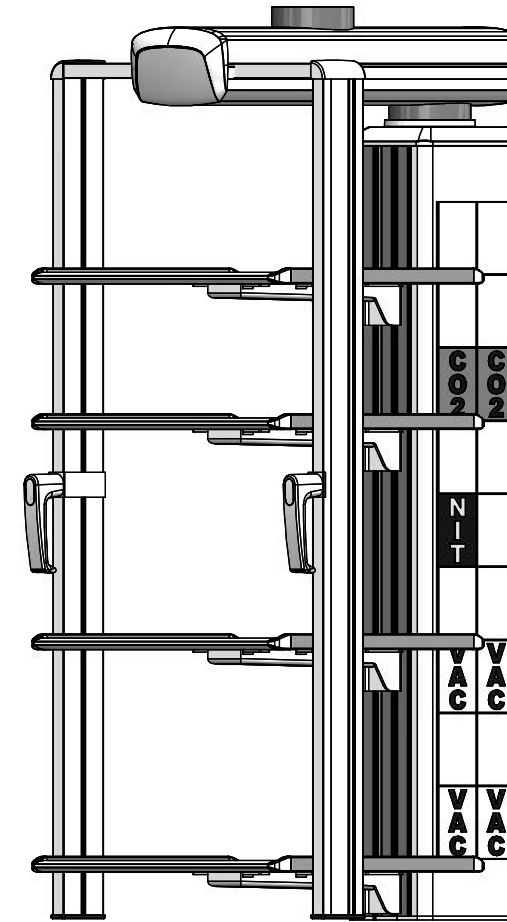
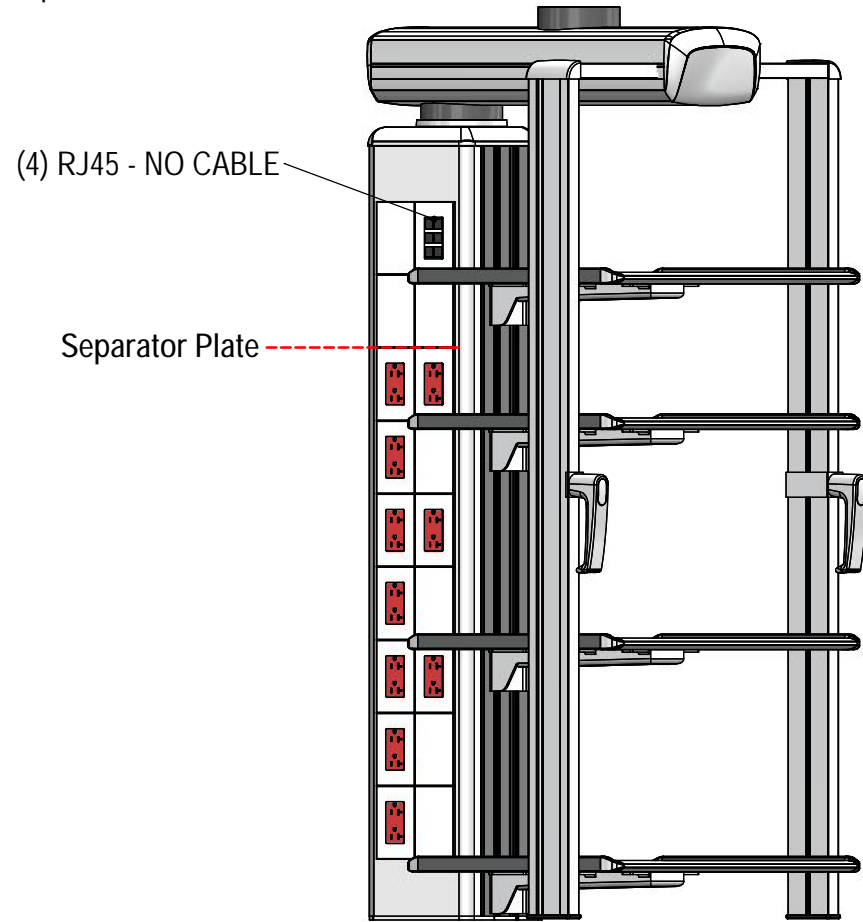

ELECTRICAL OUTLETS: (10) 125V, 20A DUPLEX - RED

GAS FACEPLATE STYLE: DISS

CARRIER DIMENSIONS: 56"H x 24"W x 28.75"D

GAS COLOR KEY:

CARBON DIOXIDE	MEDICAL AIR	OXYGEN
HELIOX	NITROGEN	VACUUM
INSTRUMENT AIR	NITROUS OXIDE	WAGD

DESCRIPTION	QTY.
CARBON DIOXIDE (DISS)	2
VACUUM	4
NITROGEN (DISS)	1

INITIAL: \_\_\_\_\_  
DATE: \_\_\_\_\_

FOR A COMPLETE LIST OF ACCESSORIES  
REFER TO YOUR QUOTE

ORTHO

REF #: C-70840  
MODEL: F320 SERIES  
DESCRIPTION: CARRIER DETAILS

QTY: 1  
REV #: 0

SHEET  
C2